

Tonellidesign

**The
New
Modernism**

Tonellidesign

The New Modernism

Tempo e spazio, due termini profondi, estrema sintesi del pensiero Tonelli nel suo percorso di sviluppo e crescita.

Il tempo porta con sé ciò che ci precede, come l'insegnamento dei maestri dell'architettura e del design, la ricerca, la passione, la loro capacità di anticipare i tempi superando la consuetudine. Ed è anche la storia della nostra azienda, di quella esperienza diffusa e speciale delle persone che l'hanno costruita. Il Tempo è condizione necessaria per quella particolare dedizione allo studio che consente di mettersi continuamente in discussione superando logiche obsolete. Il tempo, come valore perché ci vuole pazienza, attesa, coraggio e visione per arrivare all'eccellenza e introdurla nel mercato.

Lo spazio ci introduce alla casa, ai suoi volumi, alle sue componenti fisiche, funzionali e psicologiche, che incidono profondamente sulla nostra quotidianità. Il nostro spazio, quello che costruiamo giorno dopo giorno, è una sintesi complessa della nostra attitudine personale. Lo spazio come globalizzazione da cui veniamo contaminati, ma che abbiamo imparato a gestire.

E' nella relazione tra tempo e spazio che nasce la nostra contemporaneità: The New Modernism è il nostro manifesto, è ciò che crediamo sia quell'insieme di conoscenze e di esperienze, che passando attraverso spazio e tempo ci portano alla nostra interpretazione del vivere. Non è uno stile, ma un modo di rispettare le esigenze dell'abitare contemporaneo e uno stimolo a pensare prodotti che accompagnano le nostre azioni e i nostri momenti all'interno dello spazio domestico.

Tonelli protegge la sua vocazione produttiva del vetro, ma si apre ad un universo di nuovi materiali che si relazionano tra loro in un concetto di casa più ampio, che rispetta chi la abita.

Time and space, two profound terms, extreme synthesis of Tonelli's thoughts on its path of evolution and growth.

Time brings with it what preceded us, such as the teachings of architecture and design masters, the research, the passion, their ability to anticipate time by surpassing habit. And it is also the history of our company, of that widespread and special experience of the people who built the company. Time is a necessary condition for that distinctive commitment to research that allows to continuously question oneself thus overcoming obsolete logics. Time as a value, because it takes patience, courage and sight to reach excellence and introduce it to the market.

Space reminds us of our home, its volumes, its physical, functional and psychological components, that influence our everyday life profoundly. Our space, the one we build day by day, is a complex synthesis of our personal attitude. Space as the globalization we are contaminated by, but which we learned to handle.

The relation between time and space is what gives life to our modernity. The New Modernism is our manifest, what we believe is that ensemble of knowledge and experience, that through space and time brings us to our interpretation of life. It is not a style, but a way of respecting the requirements of modern living and a stimulus to think of products that accompany our actions and our moments inside the domestic spaces.

Tonelli protects its productive vocation for glass, but opens up to a universe of new materials that interact with one another in a broader concept of home, a home that respects who inhabits the space.

Manifesto

Trasparenza

La trasparenza ci appartiene, da sempre, nella materia che ogni giorno lavoriamo e nel nostro modo di presentarci.

Tatto

Il tatto, il senso con il quale sentiamo la materia e la vediamo trasformarsi.

Tradizione

Le testimonianze, la memoria, la conoscenza che portiamo con noi su ogni nuovo progetto e azione.

Tecnica

La tecnica che ci permette di progettare, costruire e sfidare nuove complessità.

Talento

Il talento dei nostri artigiani e dei designer che consideriamo un bene prezioso da tutelare e proteggere

Tempo

Il tempo, quello necessario a produrre qualità e oggetti di valore.

Transparency

Transparency is forever part of us, part of the material we work with every day and in the way we present ourselves.

Touch

Touch, the sense we use to feel the material and through which we see its transformation.

Tradition

Statements, memory, knowledge that we transmit generation after generation.

Technique

The technique that allows us to plan, build and challenge new complex ties.

Talent

The talent of our craftsmen and designers, who every day transform a thought in a project.

Time

Time, necessary to create quality and valuable objects.

Index Collection

Hemingway bookcase	23
Hyperion lamp	37
T5_Stone dining table	53
Central mirror	63
Livingstone Dark extending dining table	69
Sestante_Stone console / low tables	79
After9 side / low tables	91
Folio storage	101
VU mirror	109
Shoji Cabinet highboard	117
<hr/>	
Materials collection and data sheets	125

Collection 2020

Collezione 2020, prodotti originali che pensiamo abbiano le caratteristiche per superare il passare del tempo ed evoluzioni di prodotti eccellenti, a tutti gli effetti già oggi senza tempo presenti nel patrimonio della gamma Tonelli. La prima parte di un ben più ampio progetto che l'azienda ha in essere pensando in modo più allargato alla casa, un catalogo che è solo il primo passo dell'evoluzione dell'azienda.

Prodotti con un proprio carattere individuale legato a quella cultura del design che caratterizza la storia del marchio, ma pensati per il loro uso nella casa attraverso perfette combinazioni e relazioni.

Prodotti facenti parte di un modello di casa personale, attuale ed originale e, allo stesso tempo, grandi protagonisti dello spazio.

Naturalmente vetro, con la sua leggerezza e trasparenza, terreno in cui Tonelli è da sempre un'eccellenza, sinonimo indiscusso di modernità, ma anche altre materie, nuove pietre originali, legni e metalli in cui è cercata ed enfatizzata la loro straordinaria naturalità. È nelle relazioni tra questi elementi, dalla ricetta che ne deriva, che pensiamo si esprima la contemporaneità, un insieme di conoscenze ed esperienze che passando attraverso spazio e tempo ci portano alla nostra attuale interpretazione del vivere e dell'arredare.

Collection 2020, original products, that we think have what it takes to overcome the passing of time, and evolutions of excellent products, that are already timeless pieces of Tonelli's range of furnishings. The first part of a quite broader project the company is bringing forth thinking of home in a wider sense, a catalogue that is the first step of the company's evolution.

Products with an individual character linked to that design culture that distinguishes the brand's history, but bearing in mind the utility inside the home through perfect combinations and relations. Products that are part of a personal home model, contemporary and original, and at the same time the main characters of space.

Obviously, glass with its lightness and transparency, since ever Tonelli's excellence, undisputed synonym of modernity, but also other materials, new original stones, woods and metals, the extreme naturality of which was sought and emphasized.

The relation between these elements, and the recipe deriving from it, is what we think gives life to modernity, an ensemble of knowledge and experience that going through space and time brings us to our current interpretation of life and furnishing.



Marmo Tropikal Storm
Legni Eucalipto - Siberian Ash
Finiture su metallo Titanio spazzolato
Metalli lucidi Canna di Fucile - oro - cromo
Vetri fumé - extrachiario

Marble Tropikal Storm
Wood types Eucalipto - Siberian Ash
Metal finish brushed Titanio
Polished metal finishes gunmetal - gold - chrome
Glass types smoked - extra clear

Marmo Domus white
Vetri extrachiaro - fumé
Finiture su metallo Terracotta e Titanio spazzolato
Legni Siberian Ash - Eucalipto
Metalli lucidi Canna di Fucile - rame - cromo

Marble Domus white
Glass types extra clear - smoked
Metal finishes brushed Terracotta and Titanio
Wood types Siberian Ash - Eucalipto
Polished metal finishes gunmetal - copper - chrome

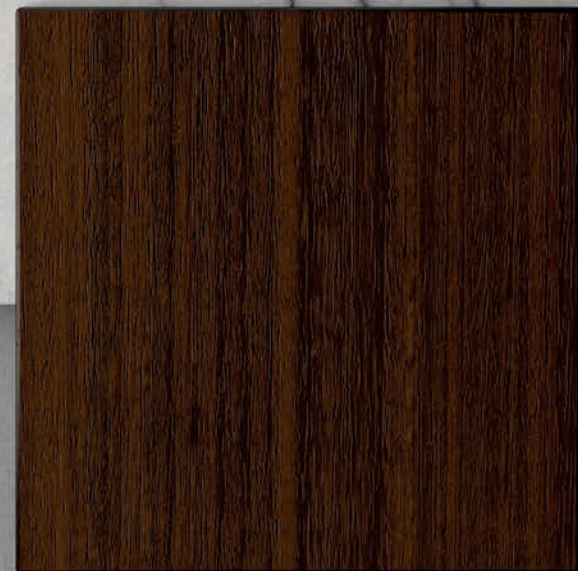
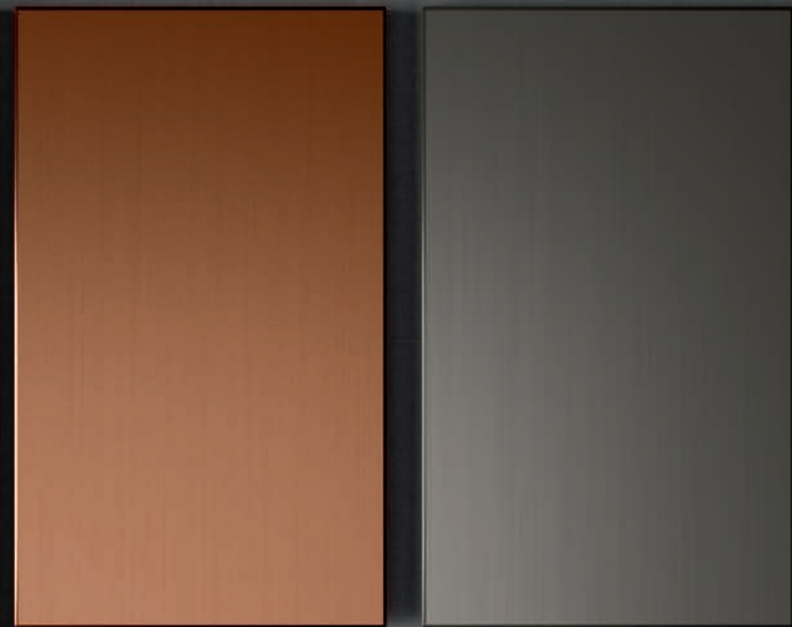
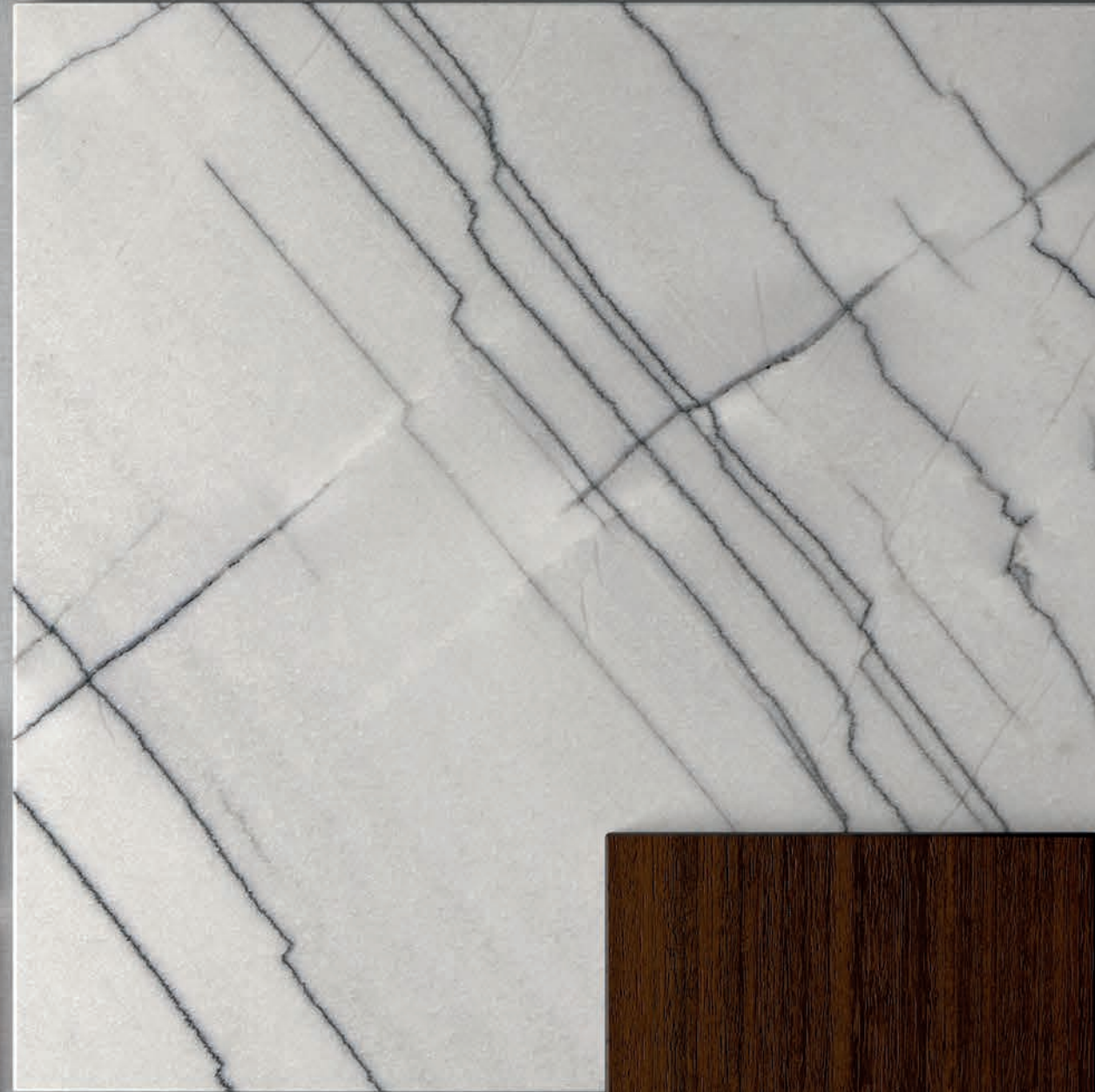



Marmo Arabescato Orobico Gold
Legni Eucalipto - Siberian Ash
Vetri bronzo - fumé - extrachiaro
Metalli lucidi Canna di Fucile - oro - cromo
Finiture su metallo Titanio spazzolato

Marble Arabescato Orobico Gold
Wood types Eucalipto Siberian Ash
Glass types bronze - smoked - extra clear
Polished metal finishes gunmetal - gold - chrome
Metal finish brushed Titanio



T5_Stone Tavolo / Table
Tropikal Storm, Titanio spazzolato, vetro
extrachiaro. / Tropikal Storm, brushed Titano,
extra clear glass.

Hyperion Lampada / Lamp
Canna di fucile lucido, vetro pyrex soffiato
trasparente. / Polished gunmetal, transparent
blown pyrex glass.

Hemingway Libreria / Bookcase
Siberian Ash / inserti cromo lucido / vetro
extrachiaro. / Siberian Ash, polished chrome
inserts, extra clear glass.

VU Specchio / Mirror





T5_Stone Tavolo / Table
Domus White, Terracotta spazzolato, vetro
extrachiaro. / Domus White, brushed Terracotta,
extra clear glass.

Hyperion Lampada / Lamp
Cromo lucido, vetro pyrex soffiato trasparente. /
Polished chrome, transparent blown pyrex glass.

Shoji Cabinet Highboard
Eucalipto, vetro fumé. / Eucalipto, smoked glass.

Central Specchio / Mirror

After9 Tavolini / Low Tables
Domus White, vetro fumé, canna di fucile lucido,
inox lucido. / Domus White, smoked glass,
polished gunmetal, polished stainless steel.

Hyperion Lampada / Lamp
Canna di fucile lucido, vetro pyrex soffiato
trasparente. / Polished gunmetal, transparent
blown pyrex glass.

Folio Storage
Vetro fumé, ceppo di Grè. / Smoked glass,
ceppo di Grè

VU Specchio / Mirror



Hemingway
bookcase

design
Massimo Castagna

Libreria con struttura in legno massello, composta da montanti e traversi, per fissaggio a muro o a soffitto. I montanti sono alleggeriti da fessure frontali e laterali e caratterizzati da inserti in metallo lucido. I traversi orizzontali ne definiscono fisicamente e visivamente la forma e la metrica. La struttura sostiene i ripiani ed i contenitori nelle varie funzioni e dimensioni.

Bookcase with solid wood structure, made of uprights and beams, wall or ceiling fixing. The uprights are made lighter by frontal and lateral slots and are characterized by inserts in polished metal. The horizontal beams physically and visually define its form and metrics. The structure supports the shelves and storage units allowing various functions and dimensions.



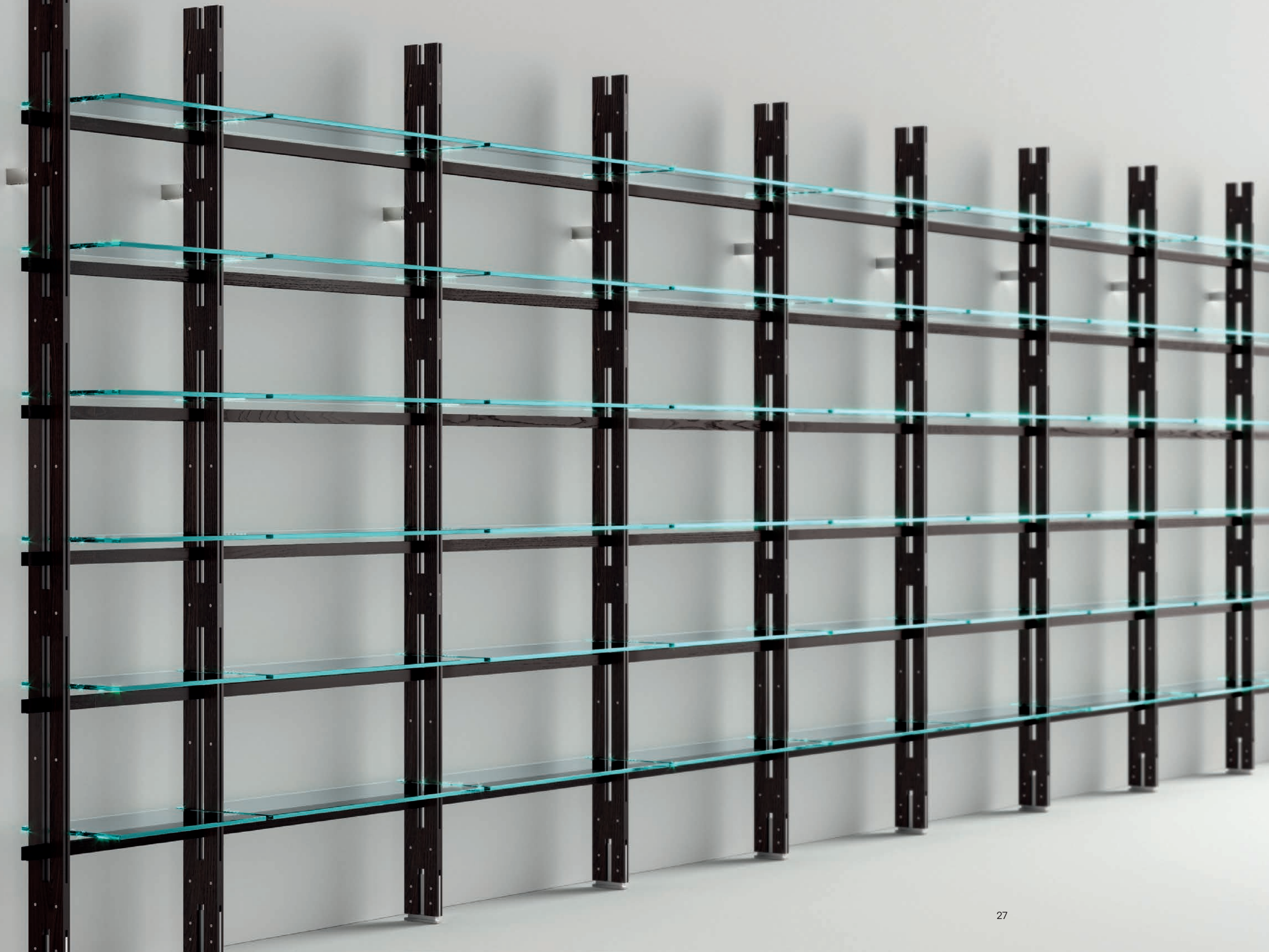



La libreria può accogliere contenitori orizzontali con apertura a ribalta verso il basso e contenitori verticali con anta a battente, realizzati con struttura in vetro e frontali in legno. Piano scrittoio in legno.

The bookcase can accommodate horizontal storage units with flap-down door and vertical storage units with hinged door, structure in glass and fronts in wood. Home office desk in wood.



I ripiani in vetro, con particolari asole laterali, sono fissati ai montanti tramite incastro sui perni. Un sistema di sicurezza anticaduta è presente su ogni ripiano.

The glass shelves, with particular lateral slots, are fixed to the uprights by an interlocking system on pins. A fall arrest security system is included with each shelf.

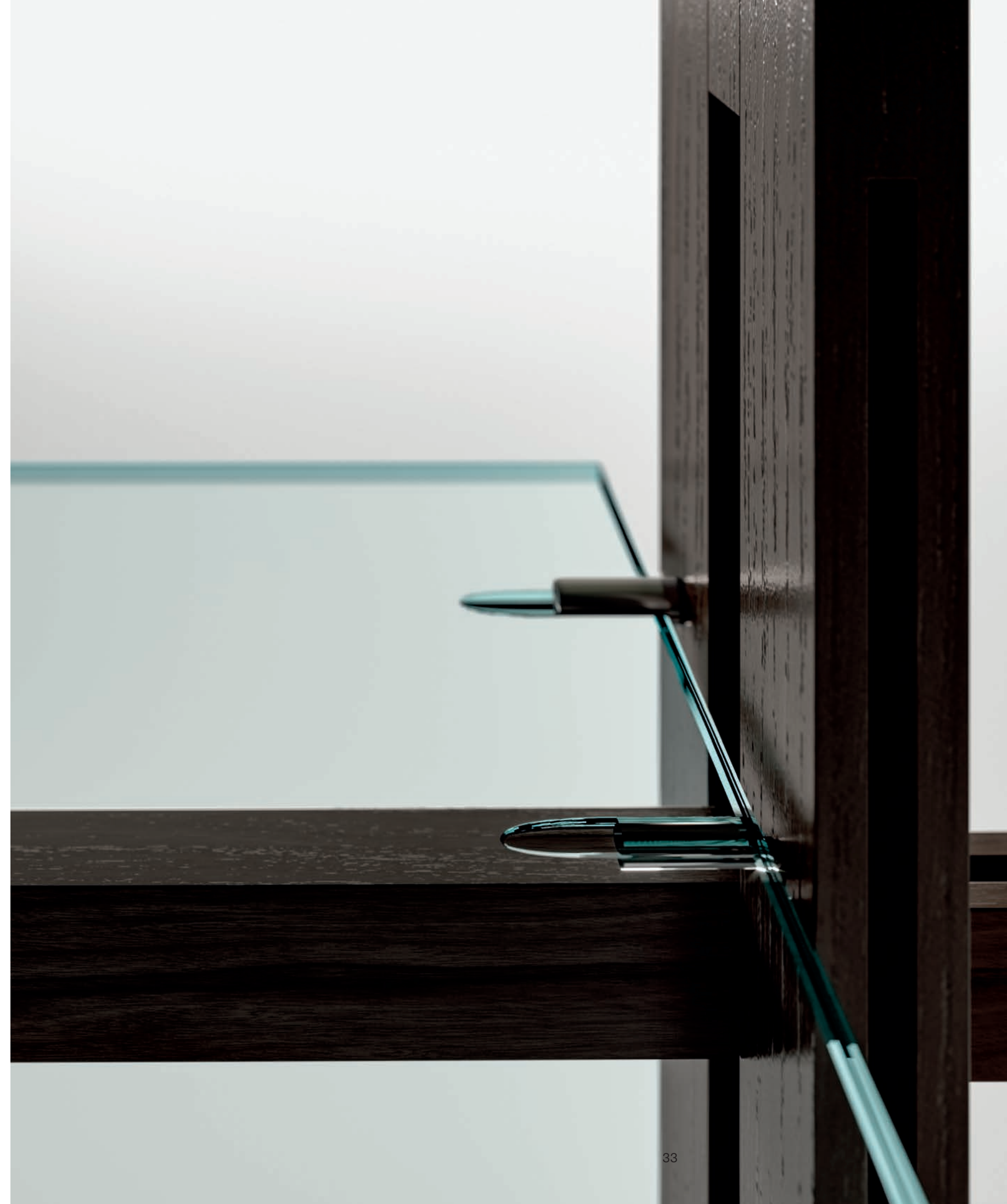



Hemingway bookcase

INFO TECNICHE / TECHNICAL INFO

Montanti verticali e traversi orizzontali in legno massello finitura Siberian Ash o Eucalipto, con inserti e supporti in cromo lucido o oro lucido. Ripiani in vetro extrachiaro o fumé. Piedi regolabili in altezza +2cm. Altezze di serie 260 e 300cm, disponibili anche su misura. Moduli da 60 e 100cm. Contenitori anta ribalta e battente con struttura in vetro fumé e ante in legno. Scrivitoio da 100cm in legno, attrezzabile con passacavo. Modulo TV con contenitore a giorno in legno da 160cm, per accogliere monitor fino a 65 pollici.

Vertical uprights and horizontal beams in solid wood finish Siberian Ash or Eucalipto, with inserts and supports in polished chrome or gold. Shelves in extra clear or smoked glass. Feet adjustable in height +2cm. Standard heights 260 and 300cm, also available in custom size. Modules of 60 or 100cm. Storage units with flap-down door or hinged door, with structure in smoked glass and doors in wood. Office desk in wood 100cm with optional cable entry. TV module with open storage unit in wood 160cm, can accommodate monitors up to 65 inches.

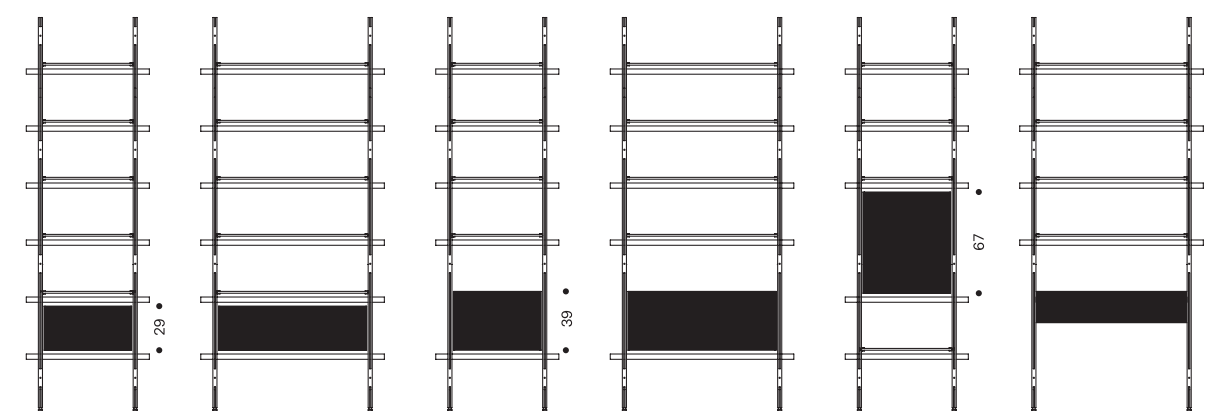
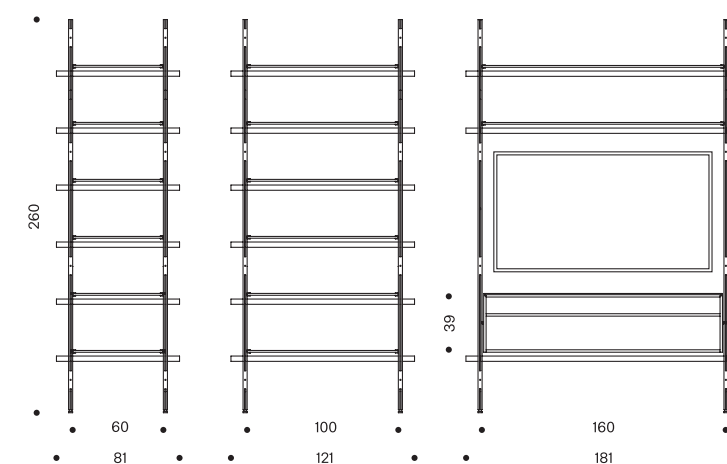

Hyperion
lamp

design
Massimo Castagna





Collezione di lampade di grande presenza scenica, caratterizzate da elementi in vetro dalla forma cubica arrotondata e struttura in metallo. Versione sospesa in due diverse configurazioni, chandelier con 5 vetri e verticale con 4 vetri. Sospensioni a vetro singolo di due diverse misure, lampada da terra nella configurazione verticale a 4 vetri.

Collection of lamps of great impact, made of glass elements with rounded cubic shape and structure in metal. Hanging version in two different configurations, chandelier with 5 glass cubes and vertical version with 4 glass cubes. Single hanging lamps in two different sizes, floor lamp in vertical configuration with 4 glass cubes.

La configurazione verticale, oltre che per l'utilizzo singolo su tavolo, è particolarmente adatta ad essere utilizzata in installazioni a lampade multiple, anche a differenti altezze.

The vertical configuration, apart from its single use on tables, is especially suitable to be used in installations of multiple lamps, also in different heights.



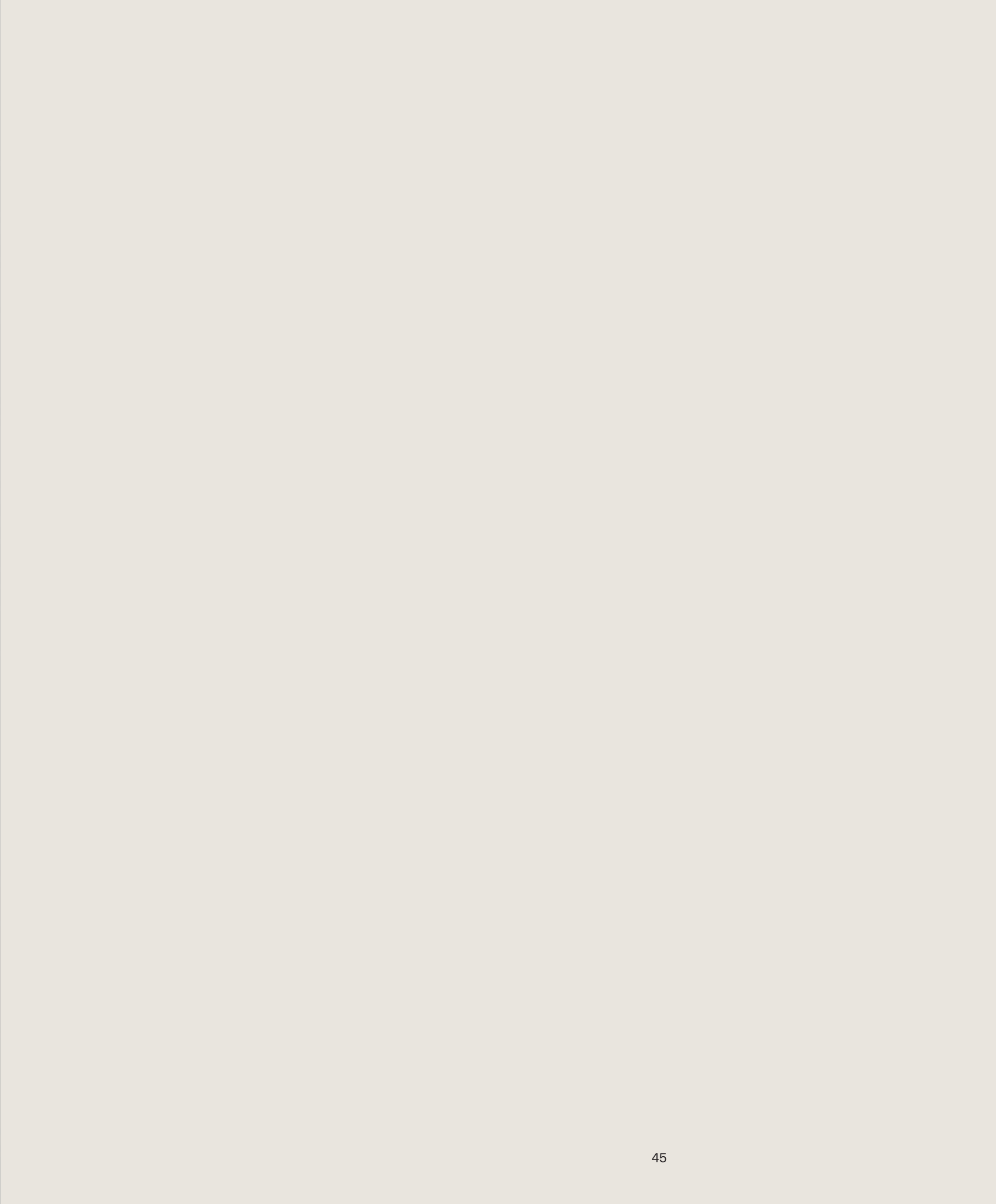



Le sospensioni singole, realizzate con le due diverse dimensioni dei vetri, sono elementi di grande pulizia formale. Utilizzabili sia per uso singolo, che per configurazioni multiple da installazione.

The single hanging lamps, made in two different glass sizes, have an extremely clean form. Can be used individually or also for multiple setups.





Hyperion lamp

INFO TECNICHE / TECHNICAL INFO

Collezione di lampade a sospensione e a terra. Luce LED G4 3000K. Lampadina dimmerabile. Cubi in vetro pyrex soffiato trasparente. Parti metalliche disponibili nelle finiture cromo lucido, oro lucido e canna di fucile lucido. L'altezza delle sospensioni può essere realizzata a misura, da un minimo di 110cm ad un massimo di 600cm totali.

Collection of hanging lamps and floor lamp. LED light G4 3000K. Dimmable bulb. Cubes in transparent blown Pyrex glass. Metal parts available in polished chrome, polished gold and polished gunmetal. Height of hanging lamps can be customized, from minimum 110cm to maximum 600cm total.

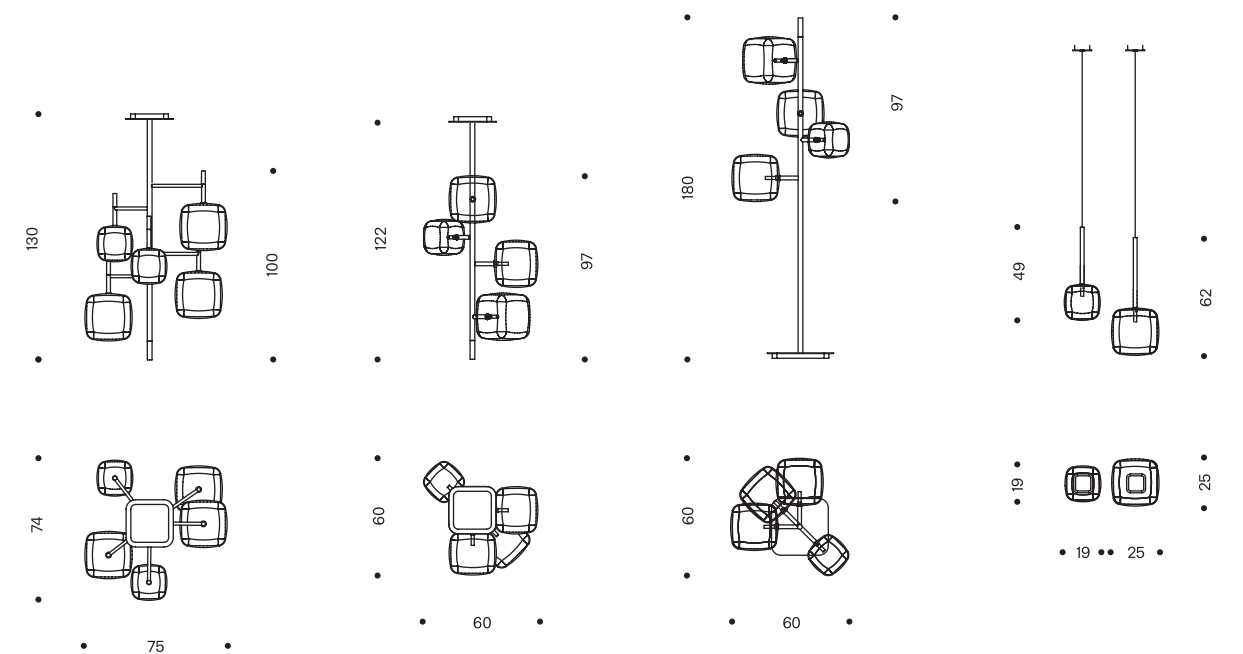

T5_Stone
dining table

design
Giulio Mancini

T5_Stone è l'evoluzione sofisticata di uno dei tavoli più apprezzati del catalogo Tonelli. Il basamento centrale è in marmo spazzolato opaco, montato in continuità di vena a valorizzarne la naturalità. I lati esterni sono in metallo, finiti con verniciature metallizzate spazzolate.

T5_Stone is the sophisticated evolution of one of the most appreciated Tonelli products. The central base is in matt brushed marble, assembled with continuous grain to enhance its naturality. The external sides are in metal, finished with metallic brushed lacquering.

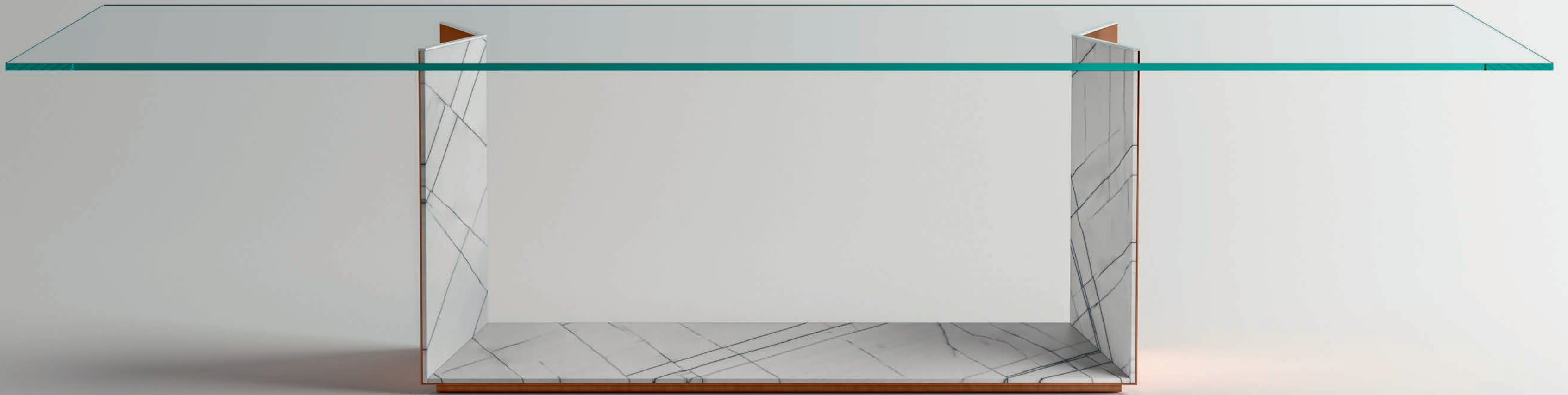

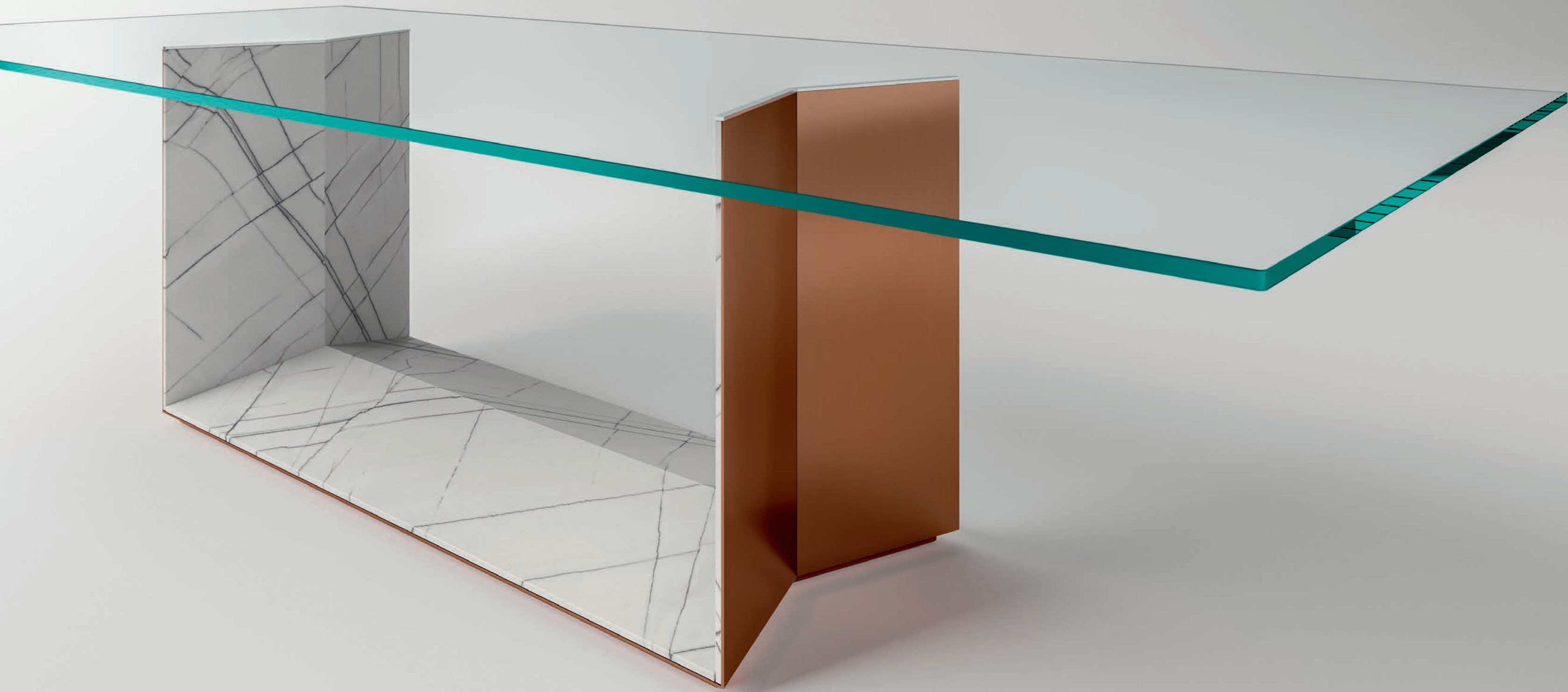

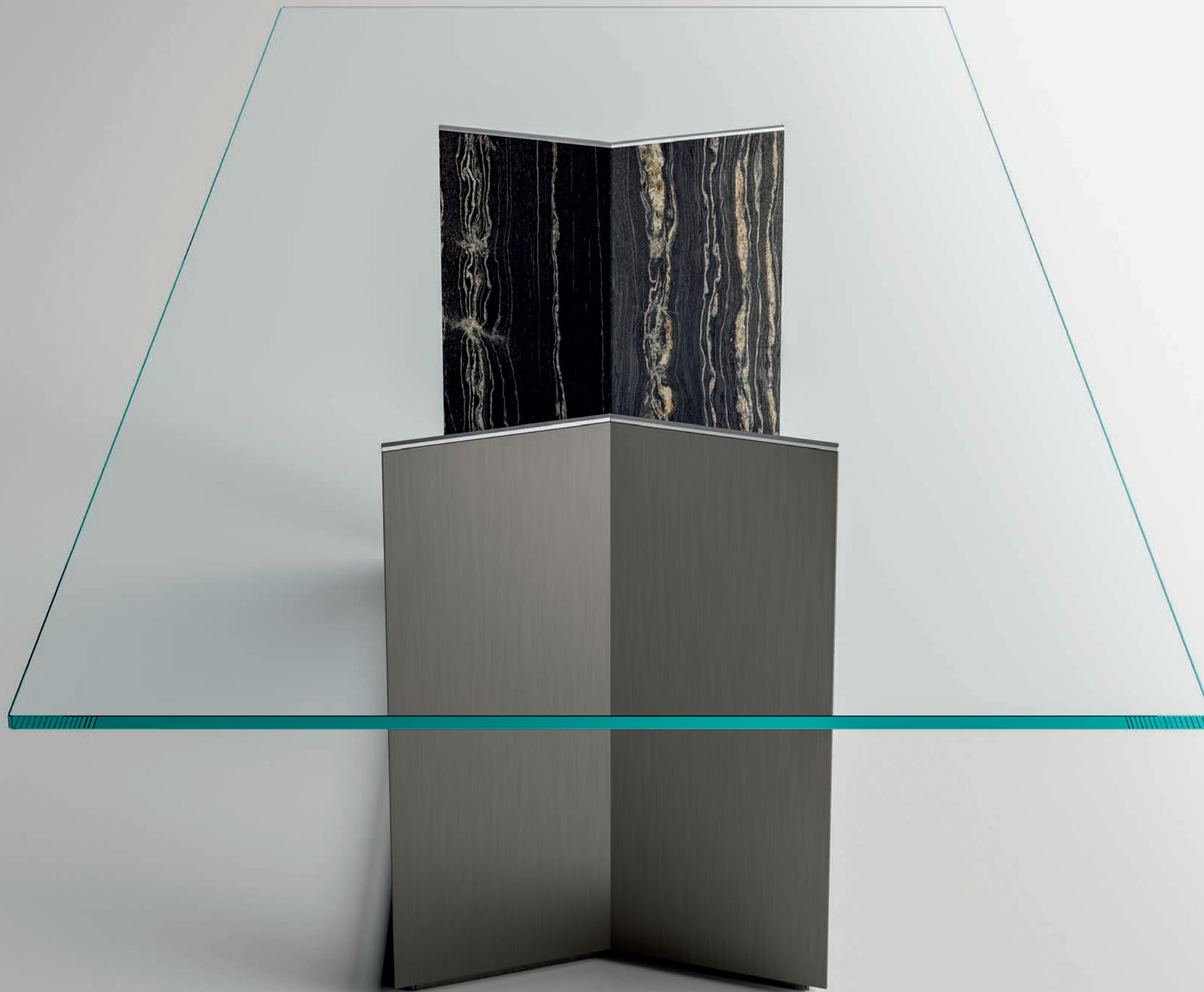

Gli abbinamenti materici e la vasta disponibilità di configurazioni e dimensioni lo rendono fortemente personalizzabile, protagonista assoluto della zona dining. La piastra in acciaio inox spazzolato incollata al top di vetro, funge sia da centraggio del piano, sia da finitura terminale del basamento.

The combining of materials and the great number of possible configurations and dimensions make it extremely easy to personalize the table, a great star of the dining space. The metal plate in brushed stainless steel glued to the glass top serves both to center the top and as terminal finish of the base.



T5_Stone dining table

INFO TECNICHE / TECHNICAL INFO

Tavolo con basamento centrale. Struttura in marmo spazzolato opaco disponibile in Arabescato Oro-bico Gold, Tropikal Storm o Domus White. Lati esterni in finitura Titanio o Terracotta spazzolati opaco. Top in vetro extrachiario temperato, incollato su piastra acciaio inox spazzolato. Basamenti disponibili in tre misure differenti, che ospitano misure di piani in vetro rettangolari, quadrati o rotondi.

Table with central base. Structure in matt brushed marble available in Arabescato Oro-bico Gold, Tropikal Storm or Domus White. External sides in matt brushed Titanio or Terracotta finish. Tempered glass top in extra clear, glued to a metal plate in brushed stainless steel. Bases available in three different dimensions, that can accommodate glass tops in rectangular, square or round shape.

Piano / Top
145 x 145
160 x 160
ø 160

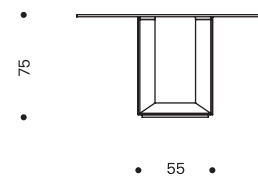
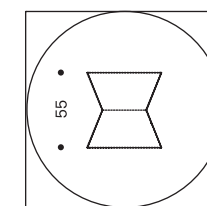

Piano / Top
200 x 100
210 x 160
220 x 100
240 x 100
240 x 120
260 x 100

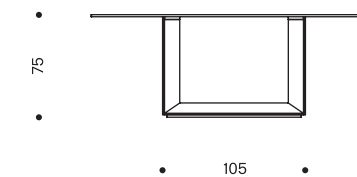
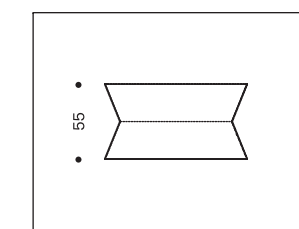

Piano / Top
280 x 100
280 x 120
300 x 100
300 x 120
320 x 120

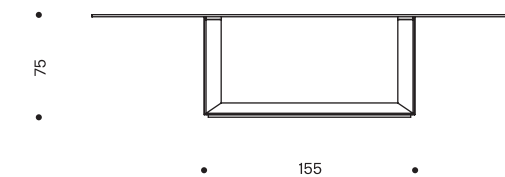
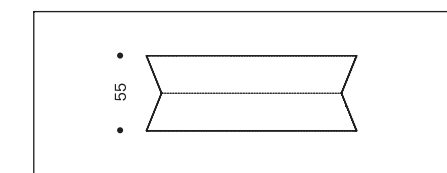

**Central
mirror**

design
Francesco Forcellini



Specchio da parete di grandi dimensioni. Lo specchio centrale rotondo, dona un senso di tridimensionalità, mentre l'immagine riflessa risulta scomposta dai pannelli laterali leggermente inclinati.

Wall mirror of big dimensions. The central mirror is round, giving a sense of three-dimensionality, while the reflected image results broken up by the slightly inclined side panels.



Central mirror

INFO TECNICHE / TECHNICAL INFO

Specchio con struttura in legno formata da due pannelli laterali e un cerchio centrale. Le finiture dei tre pannelli sono disponibili in specchio, specchio oro, bronzo o fumé, abbinabili tra di loro.

Mirror with wooden structure made of two side panels and a central circle. The finishes of the three panels are available in mirror, gold, bronze or smoked mirror, that can also be combined with one another.

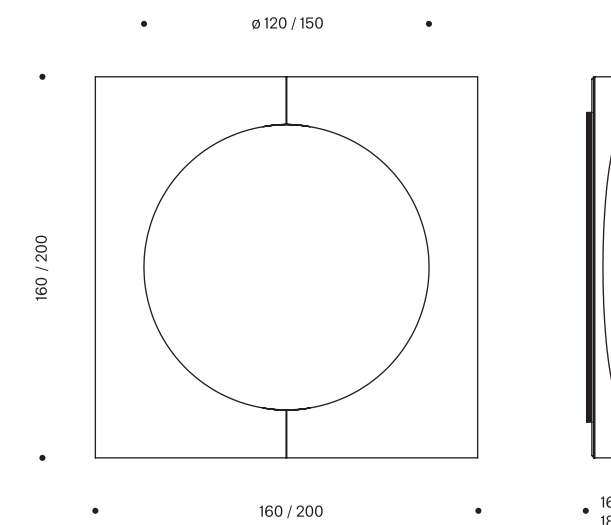

Livingstone_Dark
extending dining table

design
Giulio Mancini

La grande pulizia formale unita a contenuti tecnici di grande complessità, viene enfatizzata nel tavolo allungabile in vetro. Piani in vetro fumé o bronzo stratificato possono essere abbinati a svariate finiture di gambe.

The strong formal cleanliness combined with complex technical details is enhanced in the extending glass table. Table tops in stratified smoked or bronze glass can be combined with a number of different leg finishes.





Il movimento di apertura e chiusura del tavolo, si compie con un semplice gesto, grazie al sistema di apertura degli allunghi in vetro realizzato con una speciale cerniera in fusione di acciaio inox.

The opening and closing of the table are done with a simple gesture, thanks to the opening system of the glass leaves made of a particular hinge in stainless steel fusion.





Livingstone_Dark extending dining table

INFO TECNICHE / TECHNICAL INFO

Tavolo allungabile in vetro stratificato nelle finiture fumé e bronzo. Gambe in legno nelle nuove finiture Siberian Ash e Eucalipto si aggiungono alle finiture dei metalli, legni e pelli della gamma Tonelli.

Extending table in stratified glass available in smoked or bronze finish. Wooden legs in the new finishes Siberian Ash and Eucalipto are added to the already existing finishes in metal, wood and leather of the Tonelli range.

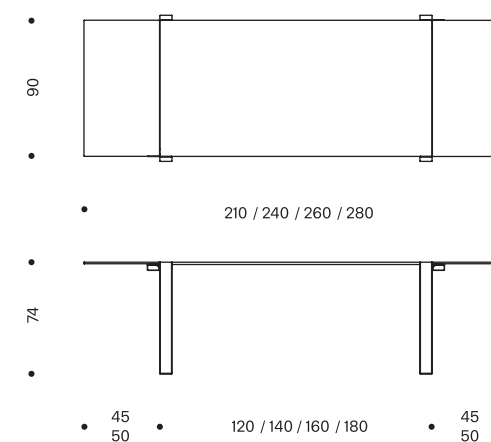

Sestante_Stone
console
low tables

design
Emilio Nanni

Tavoli bassi e consolle caratterizzati dal disegno rigoroso ed essenziale di elementi strutturali verticali, simmetrici e ortogonali. Base in vetro incollato e top in marmo spazzolato opaco, con bisellatura a vista sul piano.

Low tables and console of a rigorous and essential design given by vertical, symmetrical and orthogonal structural elements. Base in glued glass and top in matt brushed marble with visible beveled edge on the top.

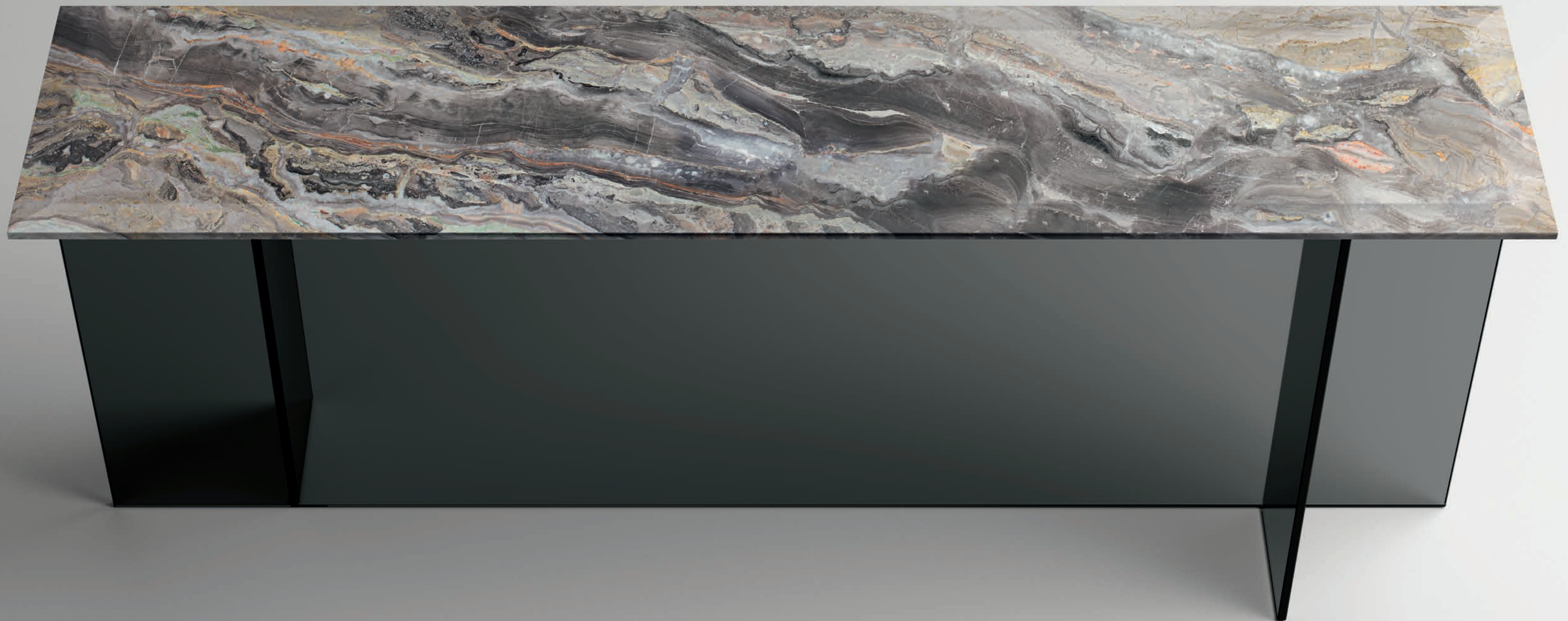



Le diverse dimensioni disponibili, permettono ampia libertà compositiva. Le varie finiture di basi in vetro e top in marmo, danno vita a innumerevoli abbinamenti e personalizzazioni.

The several available dimensions allow for a great composition liberty. The different finishing of glass base and marble top give life to numerous combinations and personalization.



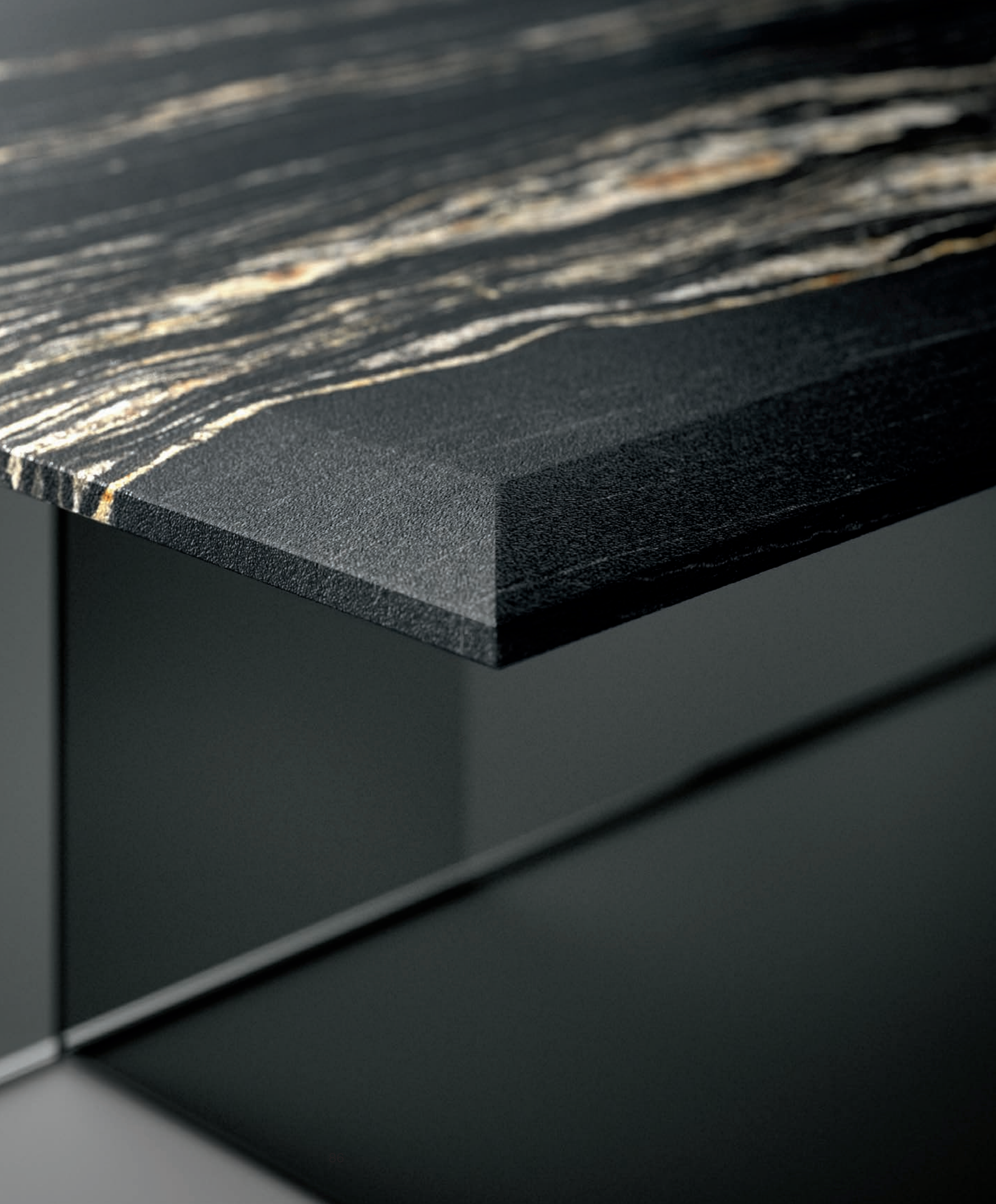



Sestante_Stone console low tables

INFO TECNICHE / TECHNICAL INFO

Collezione composta da consolle e tavoli bassi. Basi in vetro fumé o extrachiaro. Top in marmo spazzolato opaco, con bisellatura a vista, disponibile in Arabescato Orobico Gold, Tropikal Storm o Domus White.

Collection made of console and low tables. Bases in smoked or extra clear glass. Top in matt brushed marble, with bevelling on sight, available in Arabescato Orobico Gold, Tropikal Storm or Domus White.

Piano / Top
120 x 40
150 x 40
180 x 40

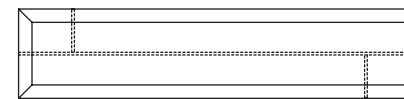

• 73 •



Piano / Top
100 x 100
130 x 70
150 x 100
150 x 150

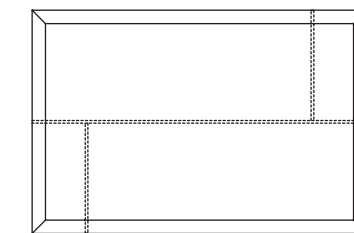

• 37 •



Piano / Top
150 x 40

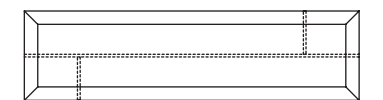

• 43 •



After9
side / low tables

design
Massimo Castagna

Collezione di tavoli bassi e fianchi divano, dalla minimale struttura in metallo con finiture in contrasto. Sono disponibili diverse dimensioni e altezze, con piani di forma organica realizzabili in vetro, legno e marmo. L'ampia gamma di finiture e forme consente accostamenti ed aggregazioni dinamiche e originali.

Collection of low tables and side tables, minimalistic metal structure with contrasting finishing. Available in different dimensions and heights, top of organic shape made in glass, wood and marble. The great range of finishing and forms allows dynamic and original combinations and aggregations.



I piani in marmo e legno sono alleggeriti ed impreziositi da una esclusiva lavorazione di bisellatura del bordo, che crea armonia tra i materiali e le forme.

The marble and wood tops are embellished by an exclusive bevelling of the edges, creating harmony between the materials and forms.

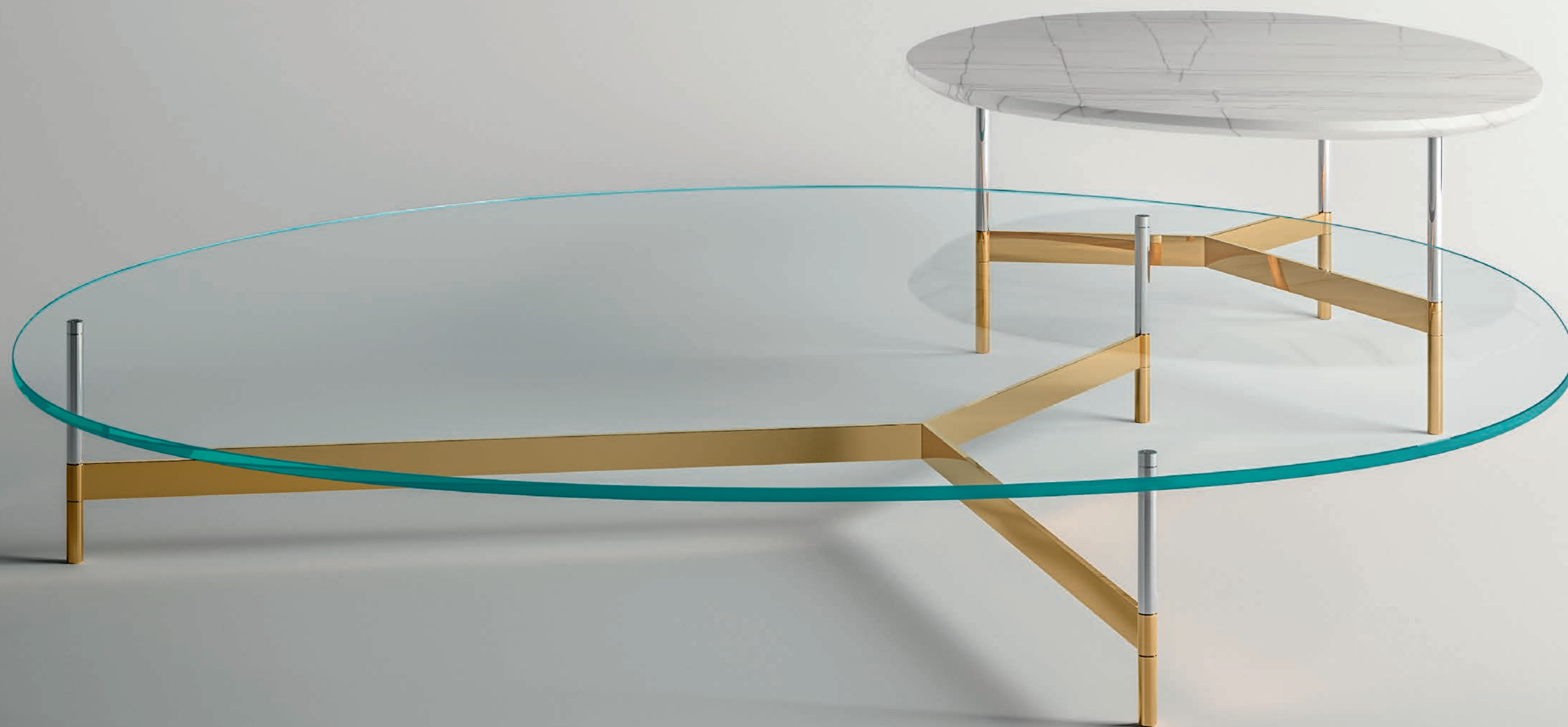



Il supporto superiore in metallo, sempre in acciaio inox lucido, dialoga con le diverse finiture del telaio inferiore, dando vita a insolite composizioni.

The upper metal support, always in stainless steel, communicates with the different finishes of the lower frame, creating unusual compositions.

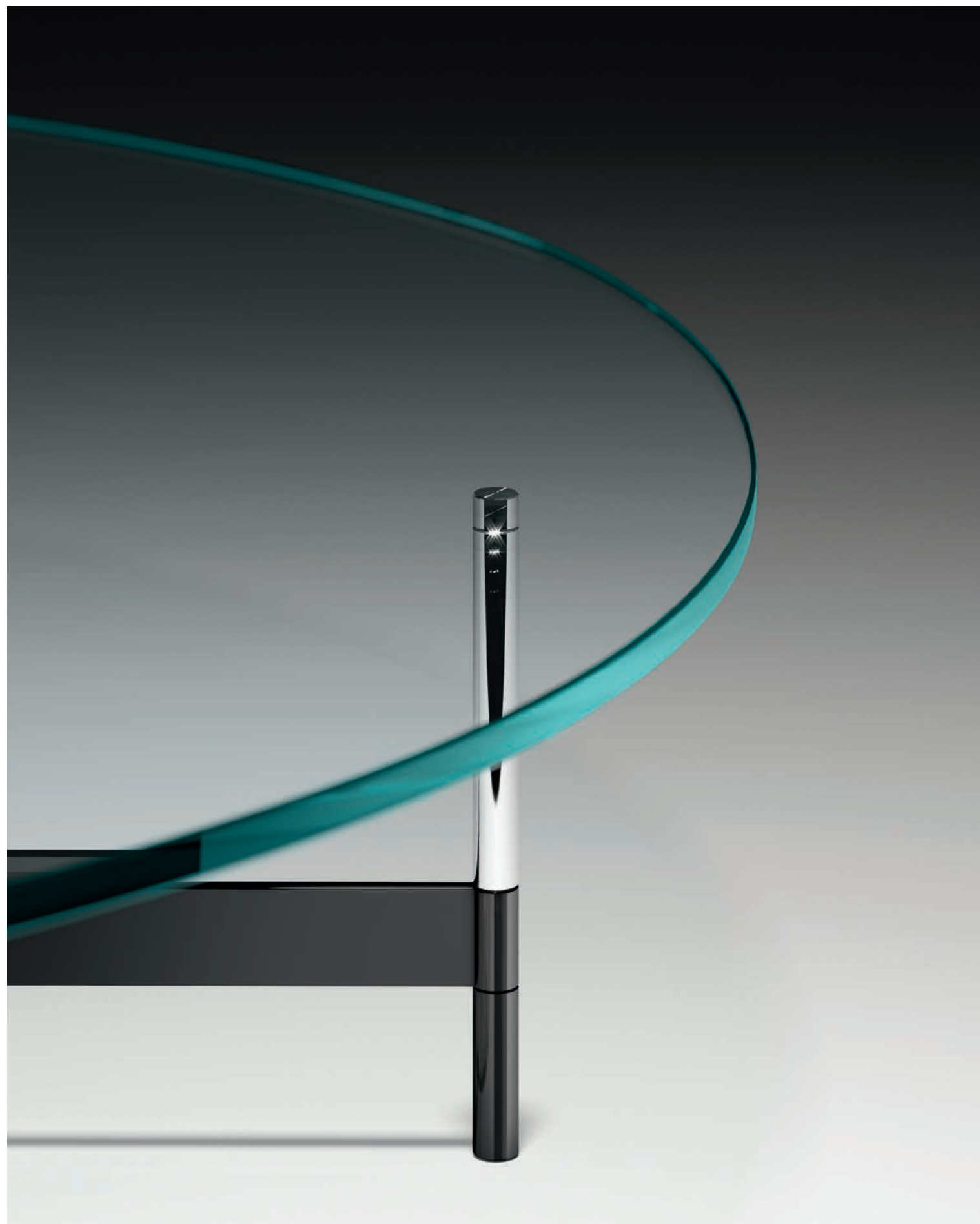

After9 side / low tables

INFO TECNICHE / TECHNICAL INFO

Collezione di tavoli bassi e fianchi divano con struttura in metallo. Supporto superiore, disponibile solo in acciaio inox lucidato, telaio e supporto inferiore, disponibili nelle finiture cromo, oro, rame, canna di fucile, lucide o spazzolate. Top in vetro extrachiaro, fumé o bronzo, legno Siberian Ash o Eucalipto, marmo Arabescato Orobico Gold, Tropikal Storm o Domus White.

Collection of low tables and side tables with metal structure. Upper support, available only in stainless steel, frame and lower support available in chrome, gold, copper, gunmetal, polished or brushed. Top in glass extra clear, smoked or bronze, in wood Siberian Ash or Eucalipto, marble Arabescato Orobico Gold, Tropikal Storm or Domus White.

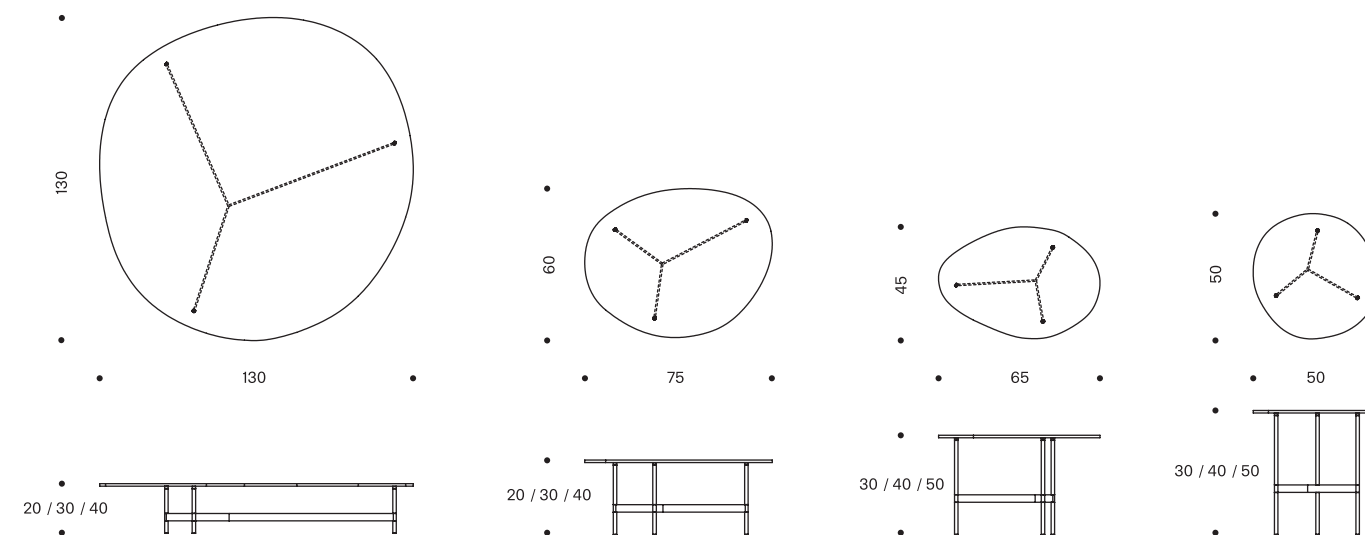

Folio
storage

design
Debonademeo Studio



Libreria freestanding in cui ogni ripiano ha una inclinazione differente per un riempimento scomposto dei libri che appariranno come volare al suo interno. La base, realizzata da un unico blocco in massello di ceppo di Grè dalla finitura sabbata volutamente irregolare, è l'elemento poetico di contrasto con la purezza e la perfezione del vetro.

Freestanding bookcase where each shelf has a different inclination, giving the books filling it a dishevelled look. The base, made of a sole block of massif ceppo di Grè sandblasted finish deliberately irregular, is the poetic element contrasting the pureness and perfection of the glass.





Folio storage

INFO TECNICHE / TECHNICAL INFO

Libreria freestanding composta da fianchi e ripiani in vetro extrachiaro o fumé. Base in granito ceppo di Gré' finitura sabbata. Appoggio a terra su piastra in acciaio inox satinato.

Freestanding bookcase, sides and shelves made of extra clear or smoked glass. Base in granite Ceppo di Gré sandblasted finish. Floor support on satin stainless-steel plate.

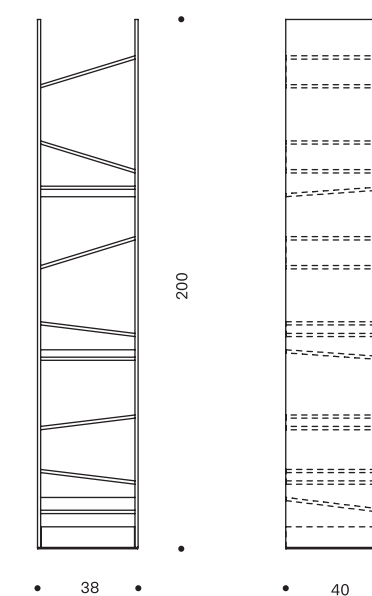

VU
mirror

design
Giovanni Tommaso Garattoni

Più che uno specchio, è un oggetto di grande valore artistico, un elemento decorativo di notevole impatto e presenza. Una texture tridimensionale ottenuta per affiancamento di diversi spessori di lastre di vetro. Ogni elemento è utilizzabile singolarmente o accostato per creare composizioni custom adattabili ad ogni esigenza di progetto.

More than a mirror it is an object of great artistic value, a decorative element of remarkable impact and presence. A three-dimensional texture obtained by placing side by side different glass thicknesses. Each element can be used individually or combined to create custom compositions adaptable to any project.



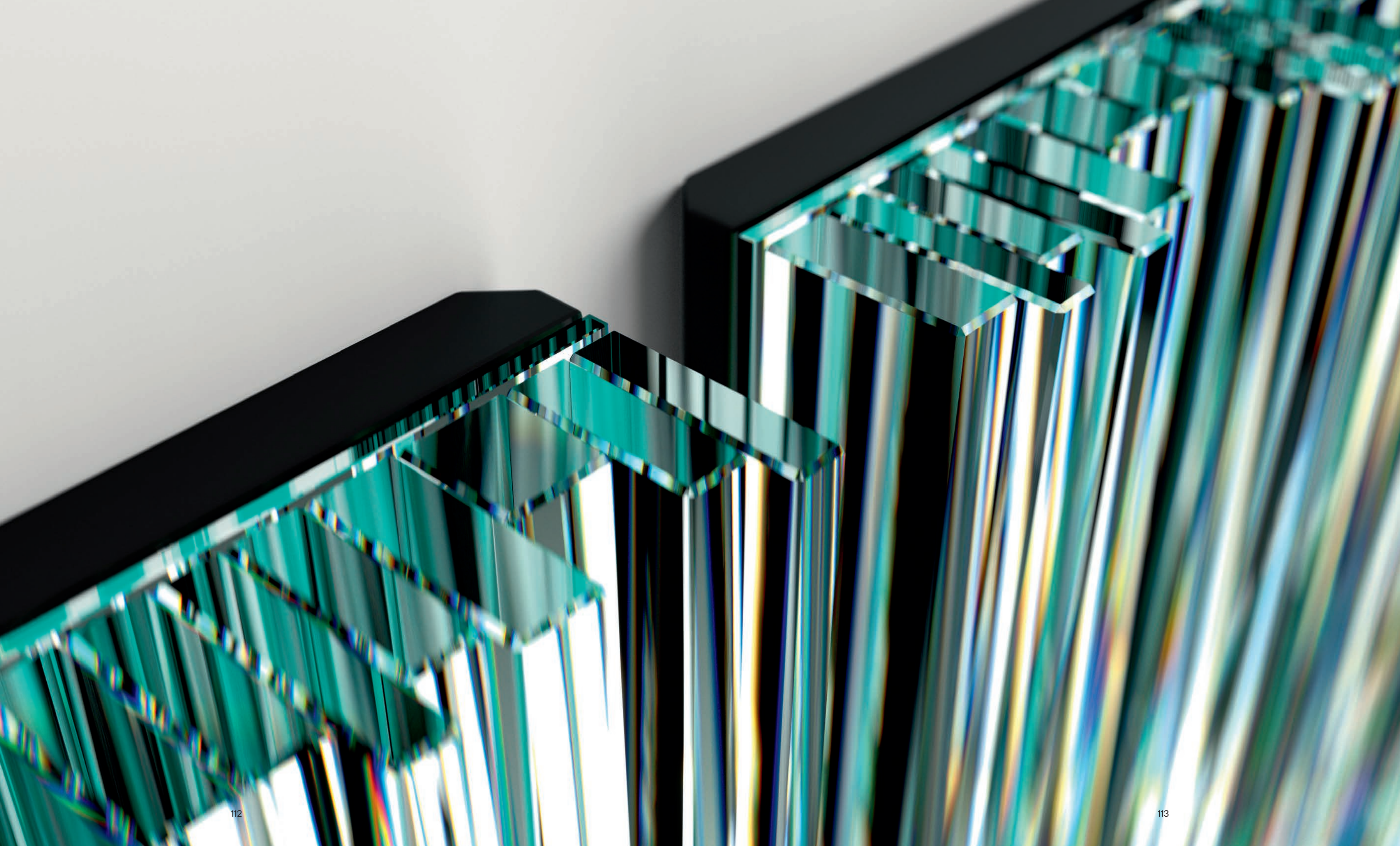



VU mirror

INFO TECNICHE / TECHNICAL INFO

Specchio modulare a parete, realizzato con lastre di vetro extrachiaro di diverso spessore accostate e saldate tra loro su un fondo a specchio. Su richiesta si possono realizzare altezze e larghezze a misura.

Modular wall mirror made of glass panels in extra clear glass of different thicknesses, put side by side and glued together on a back panel in mirror. Custom height and width available.

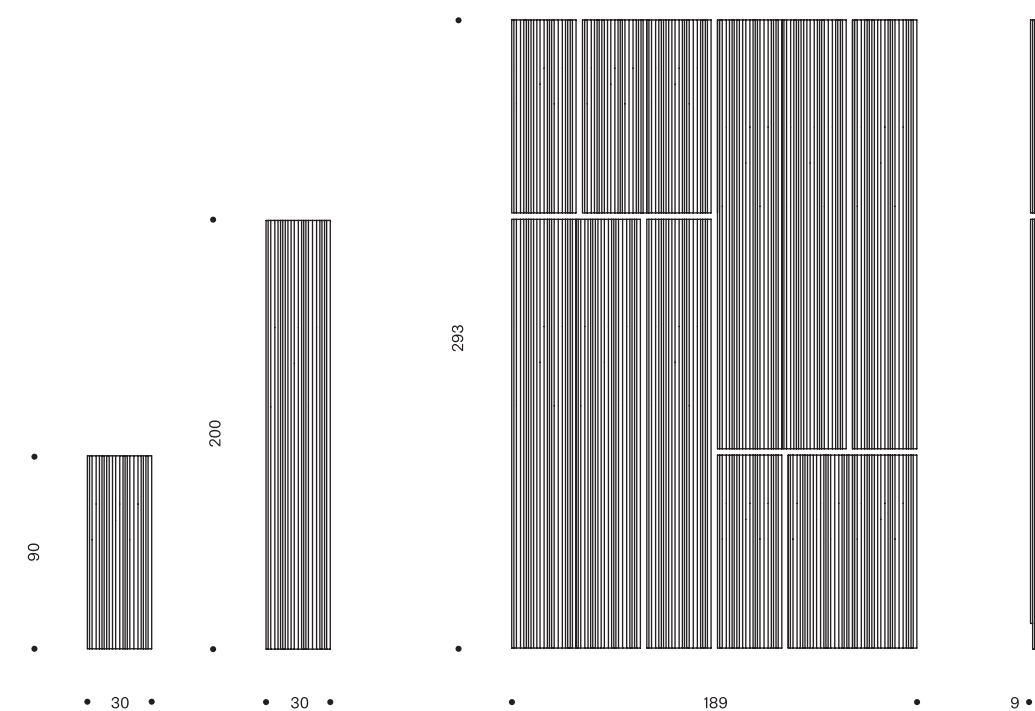

Shoji Cabinet
highboard

design
Studio Hosoe
Lorenzo De Bartolomeis

Cabinet con struttura in vetro e anta scorrevole in legno. Trova collocazione in diversi ambienti dal living alla zona notte, da una zona disimpegno all'ufficio. A seconda degli utilizzi è accessoriabile con cassettiere in legno o asta appendiabiti.

Cabinet with glass structure and sliding door in wood. Can be used in different areas, from living rooms to bed rooms, entrances or offices. Depending on its use, it can be accessorized with chest of drawers or coat hanger rod.

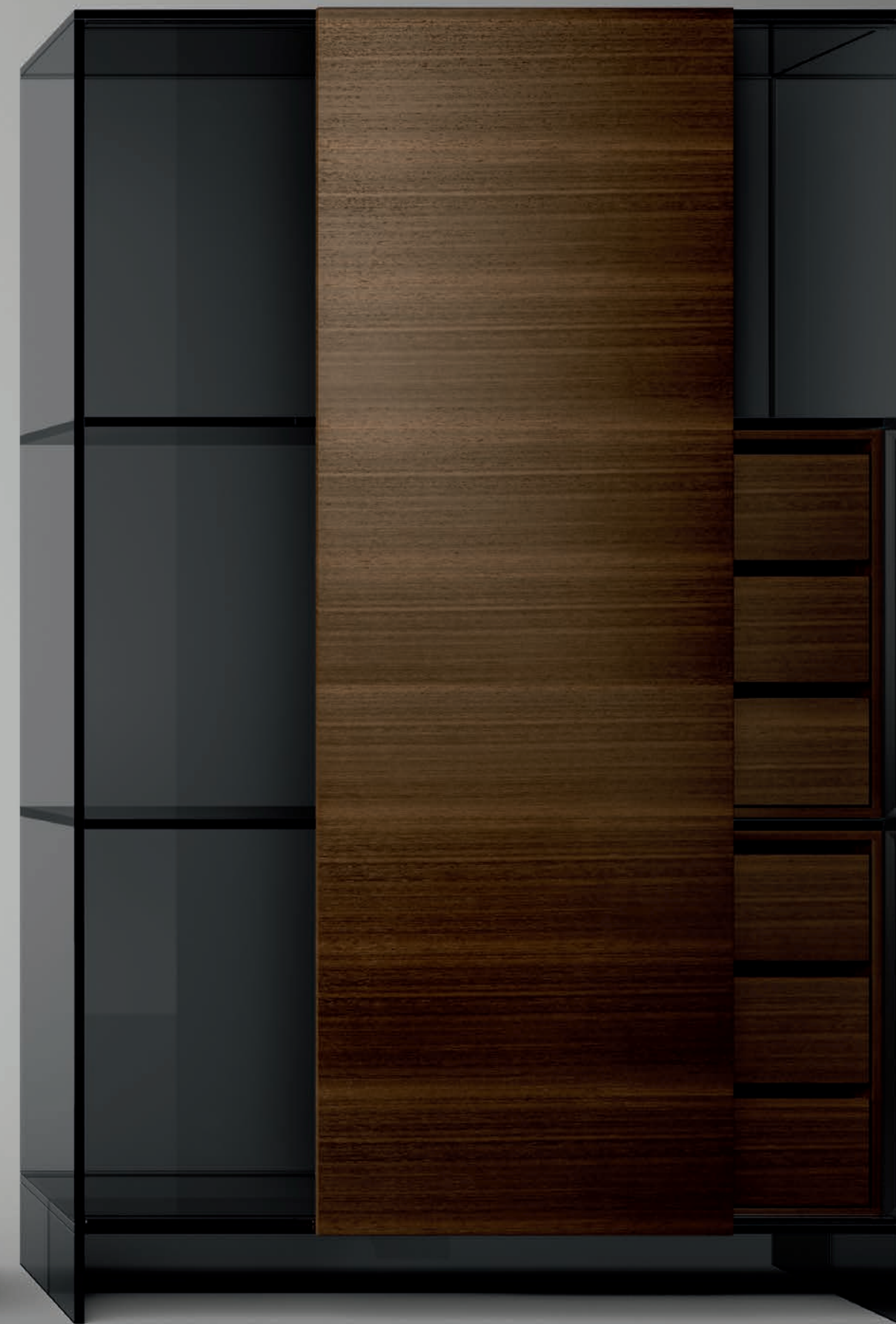





Shoji Cabinet highboard

INFO TECNICHE / TECHNICAL INFO

Cabinet disponibile in due altezze in vetro extra-chiaro o fumé. Anta scorrevole in legno Siberian Ash o Eucalipto. Opzionale cassettiere in legno Siberian Ash, Eucalipto o laccato RAL opaco.

Cabinet available in two heights in extra clear or smoked glass. Sliding door in wood Siberian Ash or Eucalipto. Optional chest of drawers in wood Siberian Ash, Eucalipto or matt RAL lacquered.

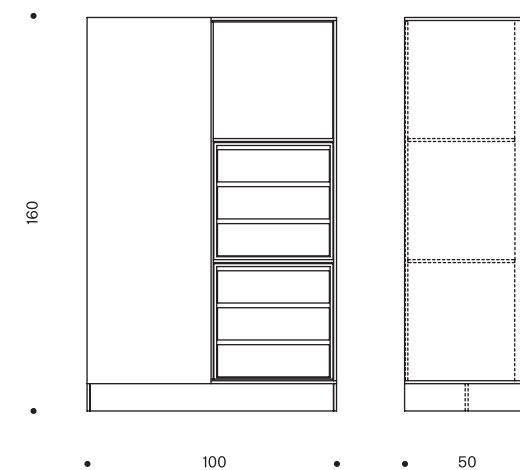
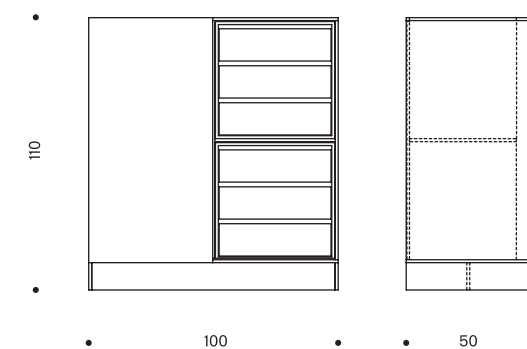

**Materials
collection
and data
sheets**

2020 Collezione materiali
2020 Materials collection

Vetro / Glass
EXTRACHIARO / EXTRA CLEAR

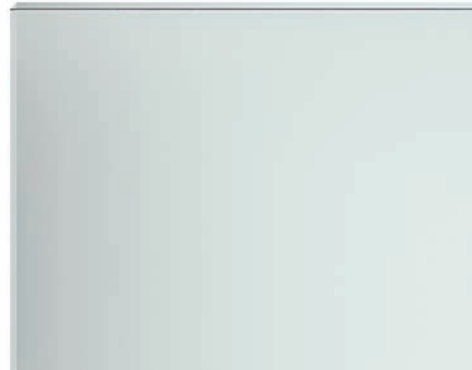

Vetro / Glass
FUMÈ / SMOKED

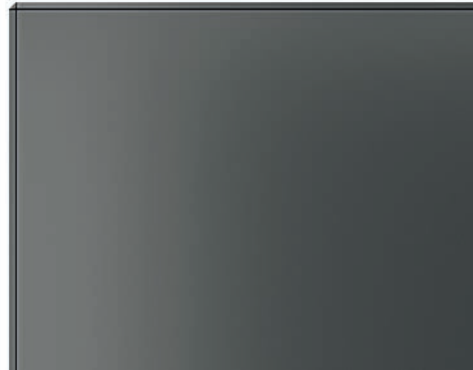

Vetro / Glass
BRONZO / BRONZE

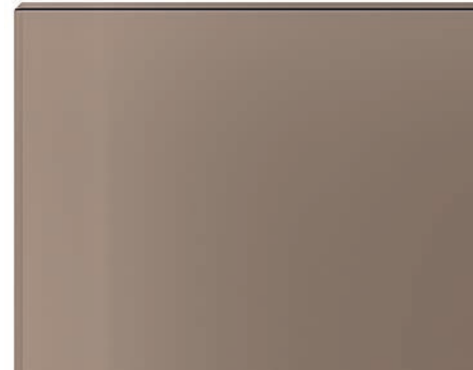

Marmo / Marble
TROPICAL STORM



FINITURA SPAZZOLATA
BRUSHED FINISHING

Marmo / Marble
ARABESCATO OROBICO GOLD

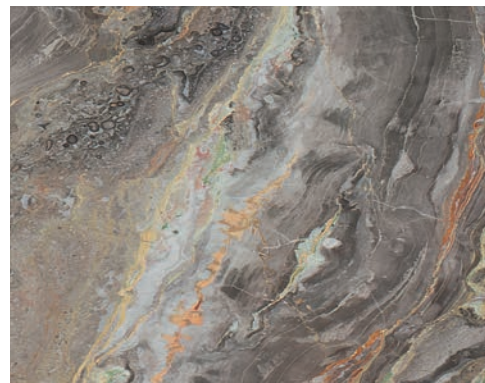

FINITURA SPAZZOLATA
BRUSHED FINISHING

Marmo / Marble
DOMUS WHITE

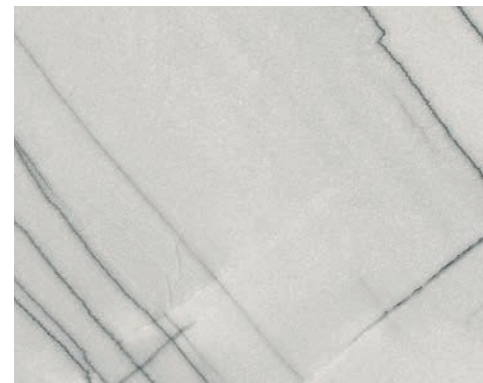

FINITURA SPAZZOLATA
BRUSHED FINISHING

Legno / Wood
SIBERIAN ASH

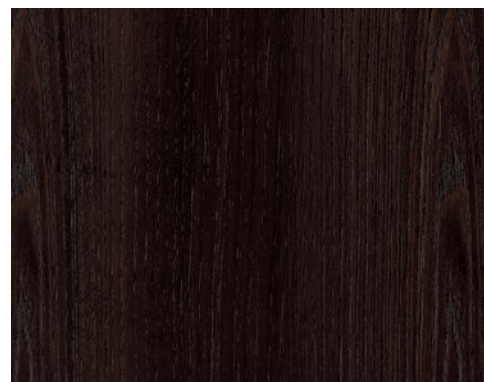

Legno / Wood
EUCALIPTO

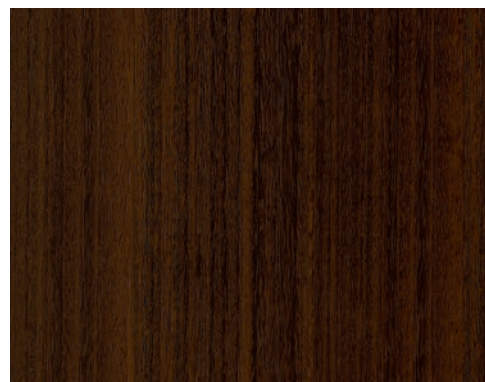

Granito / Granite
CEPPO DI GRÈ



FINITURA SABBIA
SANDED FINISHING

2020 Collezione materiali
2020 Materials collection

Metallo / Metal
CROMO / CHROME



FINITURA LUCIDA
POLISHED FINISHING



FINITURA SPAZZOLATA
BRUSHED FINISHING

Metallo / Metal
ORO / GOLD



FINITURA LUCIDA
POLISHED FINISHING

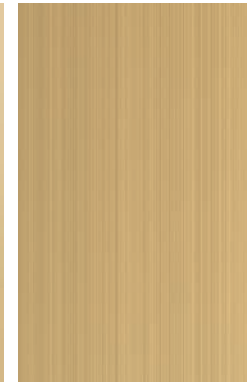

FINITURA SPAZZOLATA
BRUSHED FINISHING

Metalli / Metal
RAME / COPPER



FINITURA LUCIDA
POLISHED FINISHING

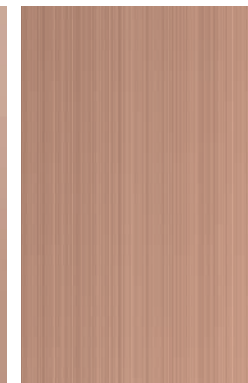

FINITURA SPAZZOLATA
BRUSHED FINISHING

Metalli / Metal
CANNA DI FUCILE / GUNMETAL



FINITURA LUCIDA
POLISHED FINISHING



FINITURA SPAZZOLATA
BRUSHED FINISHING

Finiture su metallo / Metal finishing
TITANIO

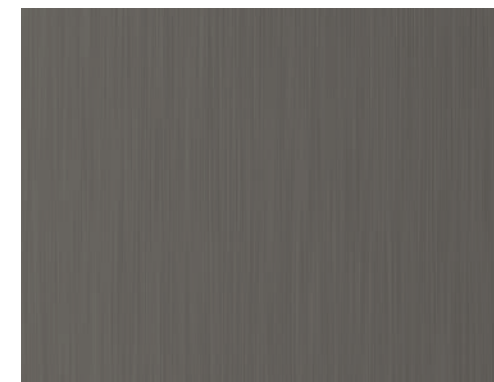

FINITURA SPAZZOLATA
BRUSHED FINISHING

Finiture su metallo / Metal finishing
TERRACOTTA

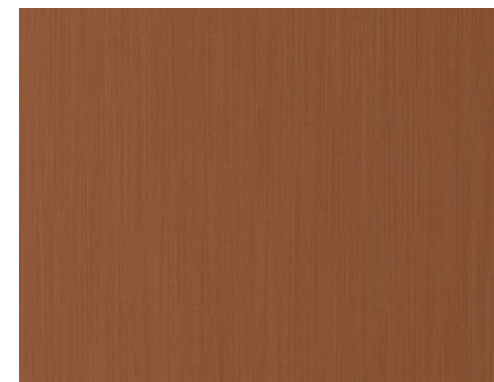

FINITURA SPAZZOLATA
BRUSHED FINISHING

La riproduzione delle finiture su carta può riportare leggere differenze cromatiche rispetto agli originali. Finishes reproductions on paper can differ slightly from the original ones.

Hemingway bookcase

Componibilità generale
General modularity

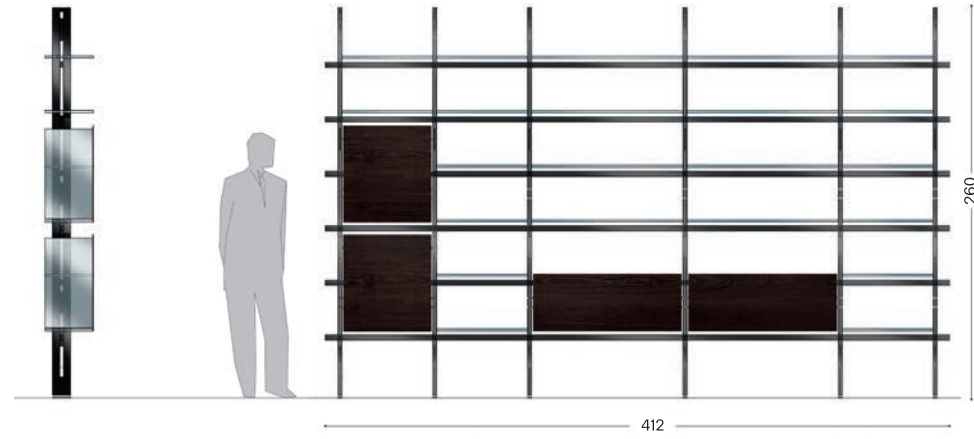

Modulo da 60 cm.
60 cm. module

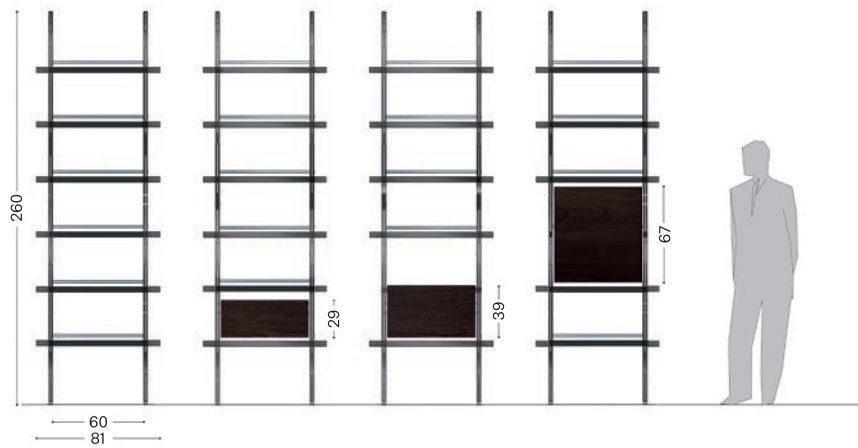

Modulo da 100 cm.
100 cm. module



Hemingway bookcase

Montanti in legno e frontali contenitori
Wooden uprights and cabinet fronts



SIBERIAN ASH

EUCALIPTO

Ripiani in vetro
Glass shelves



EXTRACHIARO
EXTRA CLEAR

FUMÉ
SMOKED

Struttura contenitori in vetro
Glass cabinets structure



FUMÉ
SMOKED

Accessori in metallo
Metal accessories



CROMO LUCIDO
POLISHED CHROME

ORO LUCIDO
POLISHED GOLD

Hemingway bookcase compositions

Comp. 601
l.412 h.260 p.37cm

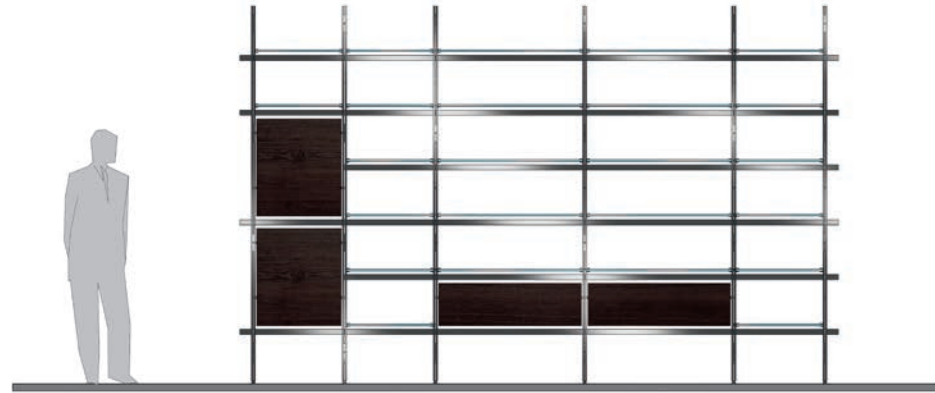

Comp. 501
l.449 h.260 p.37cm



Comp. 503
l.429 h.260 p.37cm

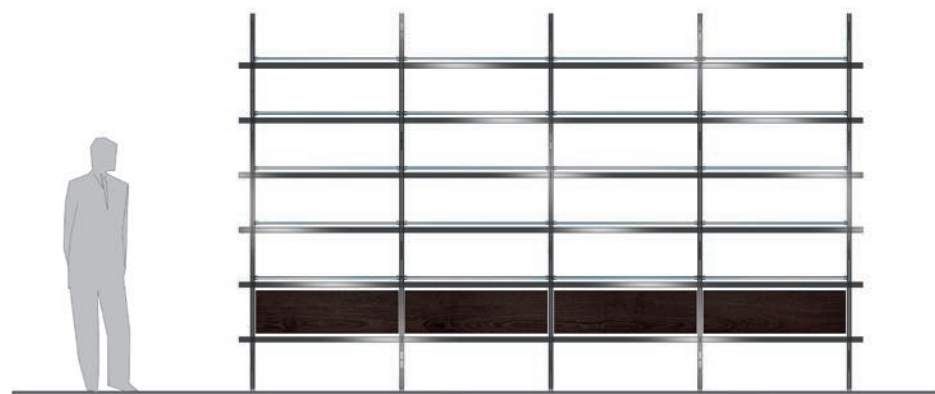

Hemingway bookcase compositions

Comp. 401
l.286 h.260 p.37cm



Comp. 303
l.184 h.260 p.63cm

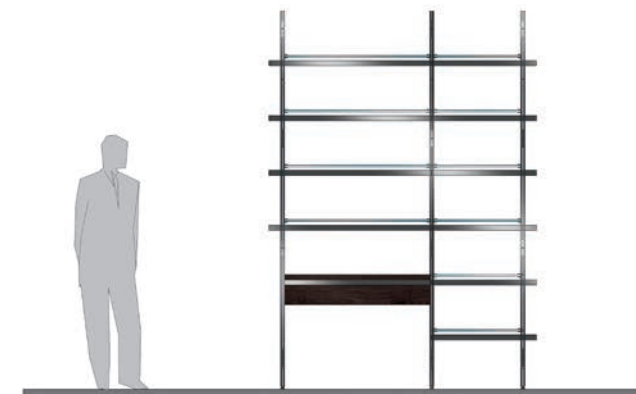

Comp. 307
l.184 h.260 p.37cm

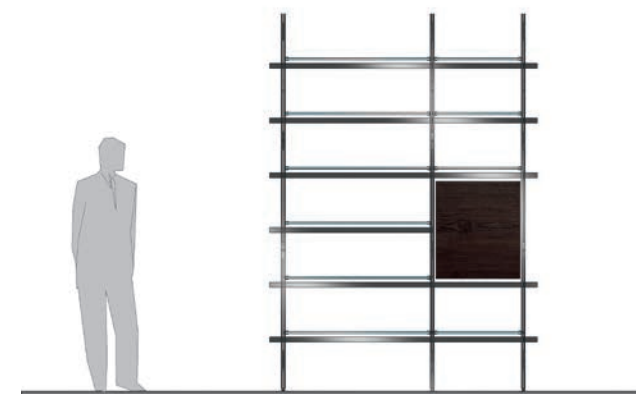

Comp. 301
l.224 h.260 p.63cm



Comp. 305
l.184 h.260 p.37cm



Comp. 405
l.326 h.260 p.37cm



Hyperion lamp

Lampada a sospensione a 4 cubi
Hanging lamp with 4 cubes

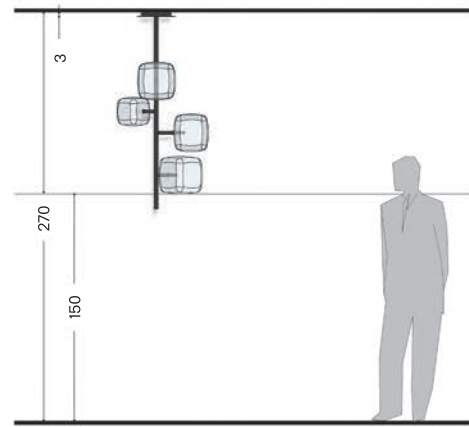

Lampada a sospensione singola
Single hanging lamp

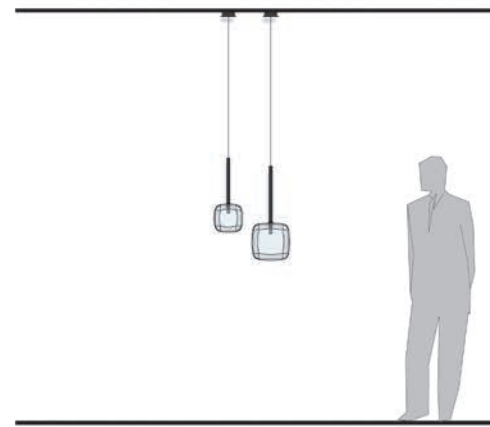

Lampada a sospensione a 5 cubi
Hanging lamp with 5 cubes

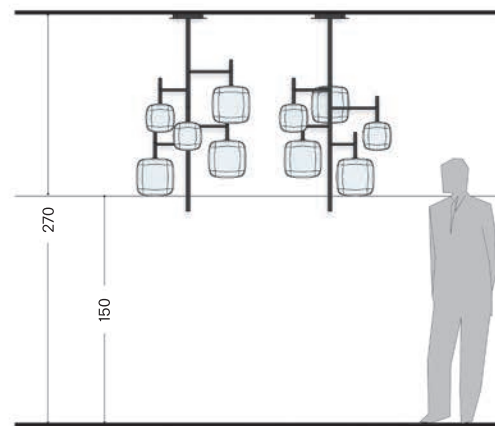

Lampada a terra a 4 cubi
Floor lamp with 4 cubes

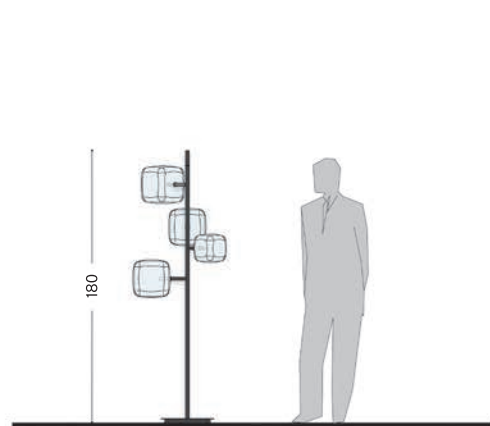

Struttura in metallo
Metal structure



CROMO LUCIDO
POLISHED CHROME

ORO LUCIDO
POLISHED GOLD

CANNA DI FUCILE LUCIDO
POLISHED GUNMETAL

Vetro lampada
Lamp glass



PYREX SOFFIATO TRASPARENTE
TRANSPARENT BLOWN PYREX

Folio storage

Modularità
Modularity

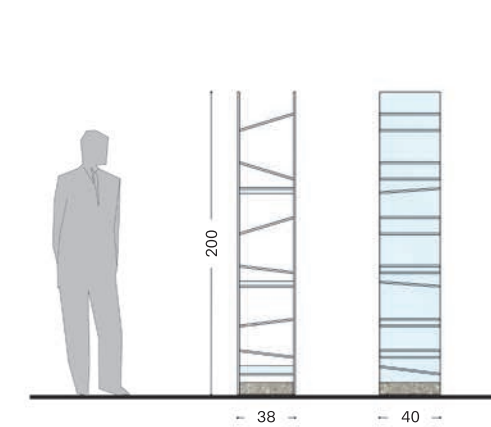

Struttura vetro
Glass structure



EXTRACHIARO
EXTRA CLEAR

FUMÉ
SMOKED

Base marmo finitura sabbata
Sanded finishing marble base



CEPPO DI GRÈ

T5_Stone dining table

Basamento 155 Table base 155

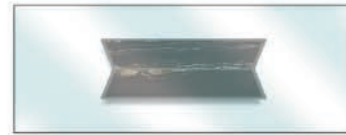

320x120

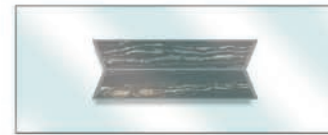

300x120

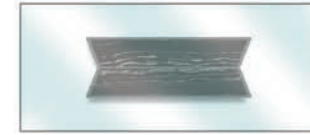

280x120

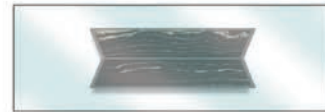

300x100



280x100

Basamento 105 Table base 105



210x160



260x100

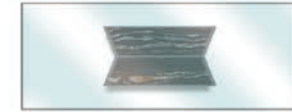

240x120



240x100



220x100

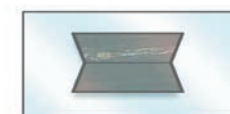

200x100

Basamento 55 Table base 55



Ø160

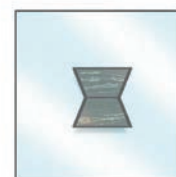

160x160

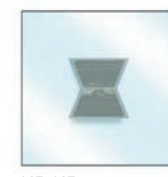

145x145

T5_Stone dining table

Lati esterni basamento in metallo External sides of metal base



TITANIO SPAZZOLATO
BRUSHED TITANIO



TERRACOTTA SPAZZOLATO
BRUSHED TERRACOTTA

Lato interno basamento marmo spazzolato Internal side of base with brushed marble

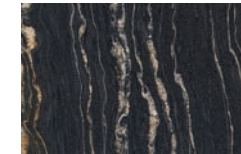

TROPIKAL
STORM

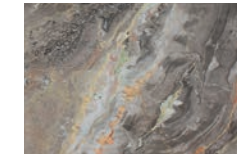

ARABESCATO
OROBICO GOLD



DOMUS
WHITE

Top vetro Glass top



EXTRACHIARO
EXTRA CLEAR

Livingstone_Dark extending dining table

Tavolo allungabile in varie dimensioni (*)
Extending table in various sizes (*)

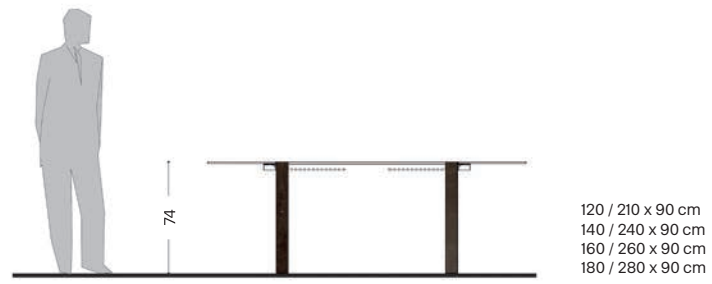

Gambe in legno
Wood legs



SIBERIAN ASH

EUCALIPTO

Gambe in metallo
Metal legs



CANNA DI FUCILE LUCIDO
POLISHED GUNMETAL

Piano in vetro
Glass top

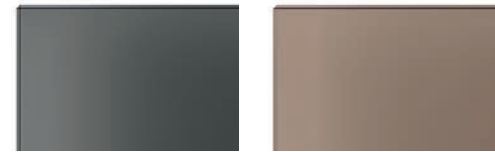

FUMÉ
SMOKED

BRONZO
BRONZE

(*) Elenco completo finiture, vedi listino 2019
(*) Complete list of finishes, see price list 2019

Central mirror

Modularità
Modularity

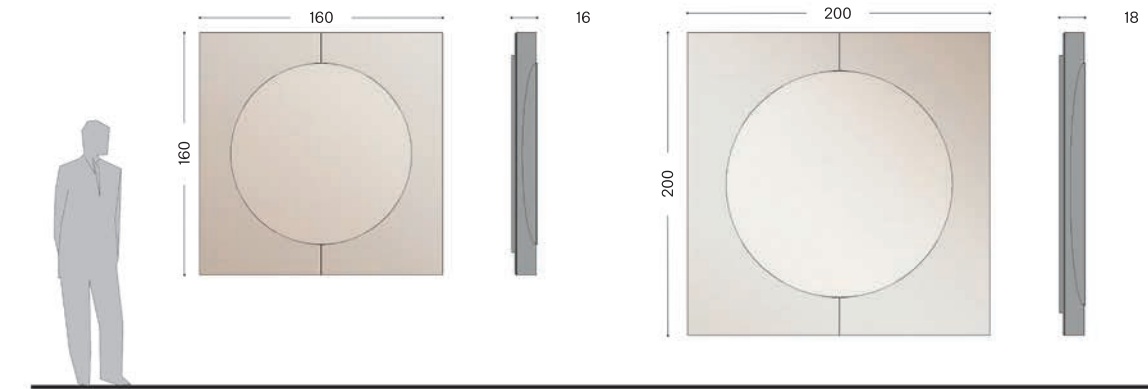

Specchi esterni / Specchio centrale
External mirrors / Central mirror



SPECCHIO
MIRROR



FUMÉ
SMOKED



BRONZO
BRONZE



ORO
GOLD

Sestante_Stone console and low tables

Consolle H. 73 cm
Console H. 73 cm

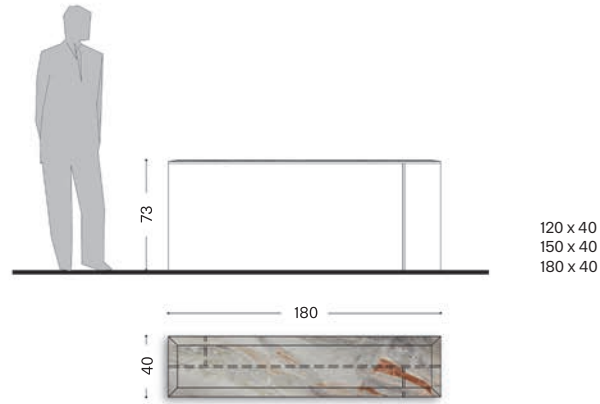

Tavolo basso H. 37 cm
Low table H. 37 cm

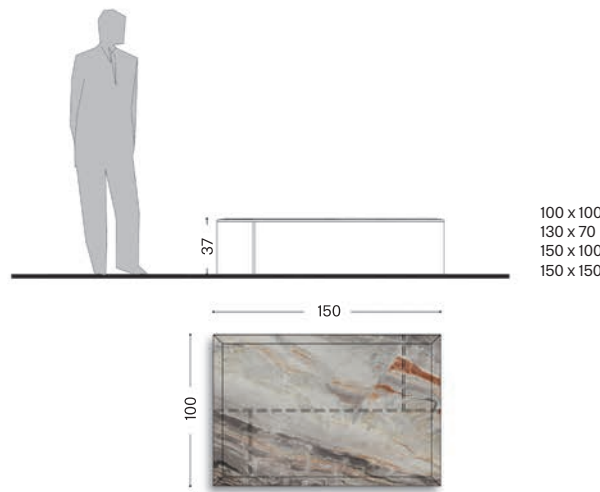

Tavolo basso H. 43 cm
Low table H. 43 cm

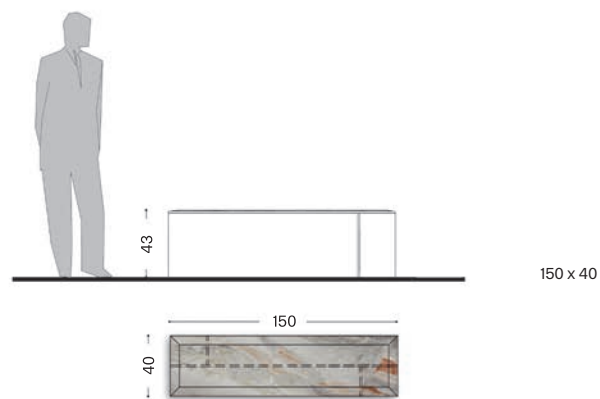

Sestante_Stone console and low tables

Struttura in vetro
Glass structure

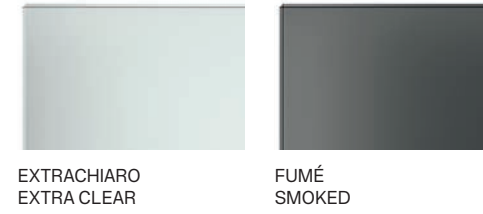

Top in marmo spazzolato
Brushed marble tops



After9

side / low tables

Modularità Modularity

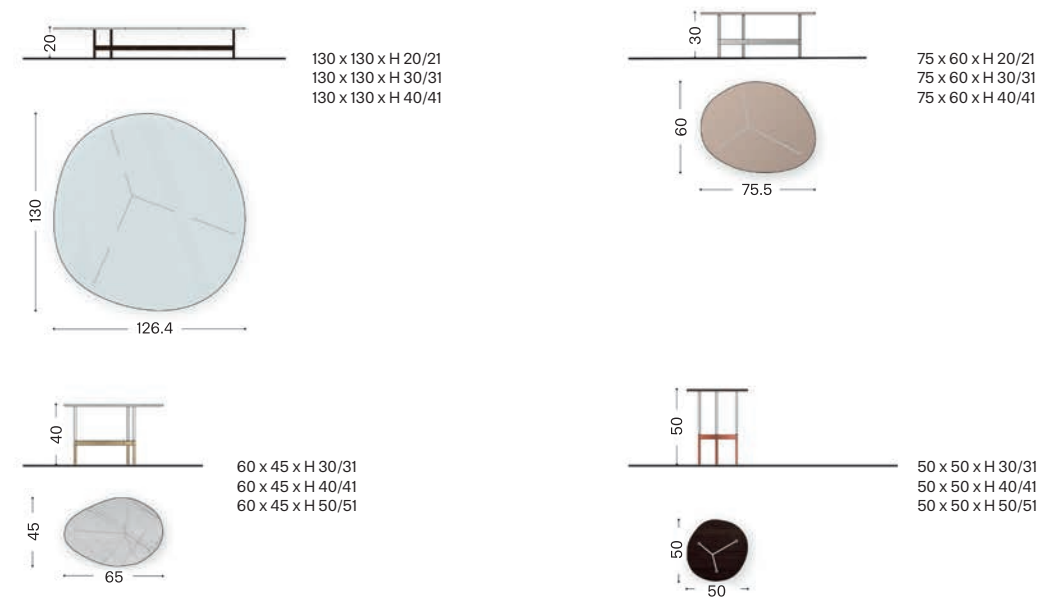

Esempi compositivi Example of compositions

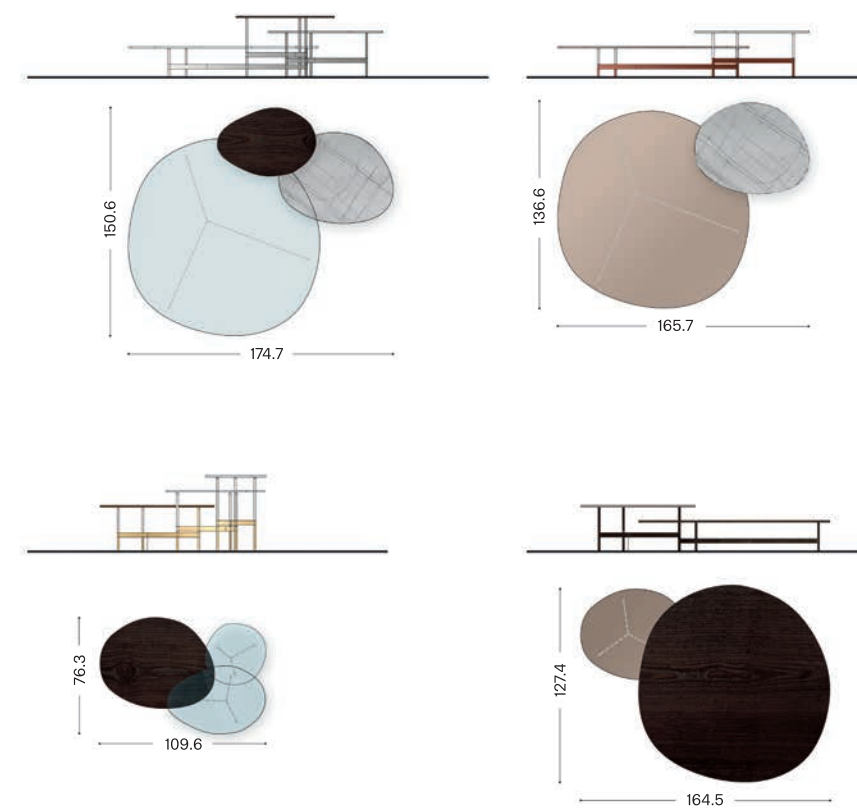

After9

side / low tables

Top vetro Glass top



Top legno Wood top

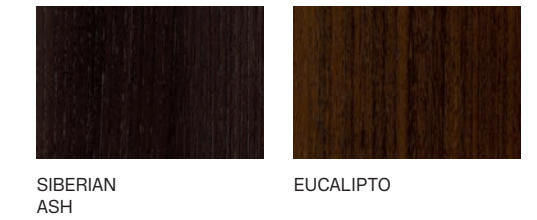

Top in marmo spazzolato Brushed marble tops

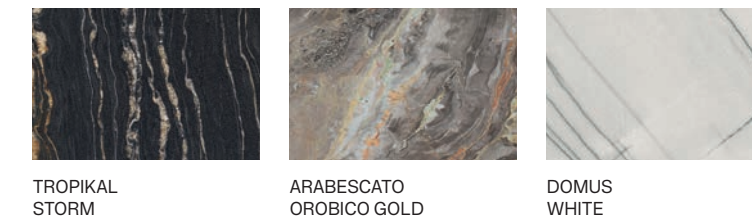

Supporto superiore in metallo Metal upper support



Telaio e supporto inferiore in metallo Metal frame and lower support



VU mirror

Modularità Modularity

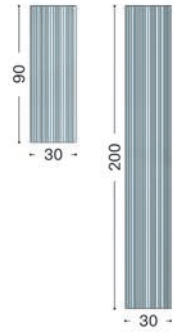

Esempio compositivo Example of composition

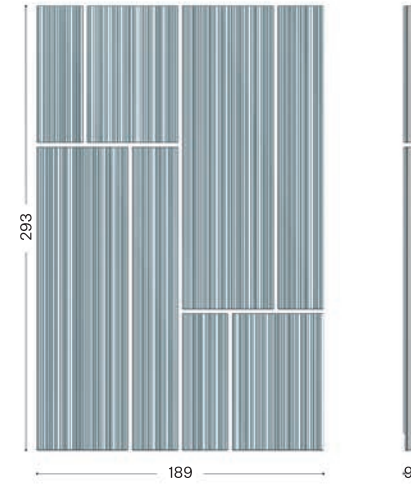

Specchio Mirror



SPECCHIO
MIRROR

Vetri frontali Front glasses



EXTRACHIARO
EXTRA CLEAR

Shoji Cabinet highboard

Modularità Modularity

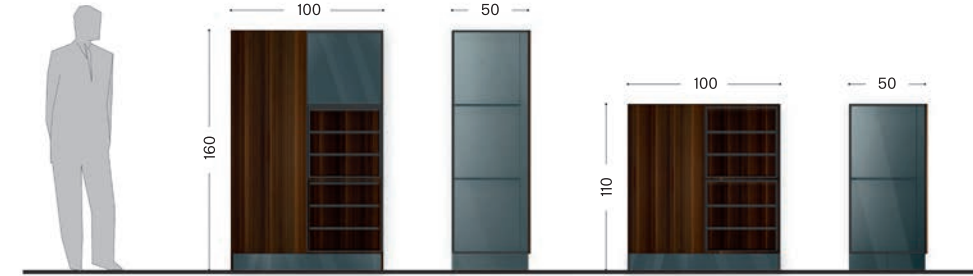

Struttura vetro Glass structure



EXTRACHIARO
EXTRA CLEAR



FUMÉ
SMOKED

Ante e cassettiere legno Doors and wooden chest of drawers

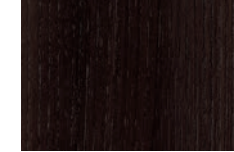

SIBERIAN
ASH



EUCALIPTO

Tonellidesign

Tonellidesign